

ALL ABOUT COLOR

ALISEO

G E R M A N Y

2024

GERMAN
HOSPITALITY
TRADITION

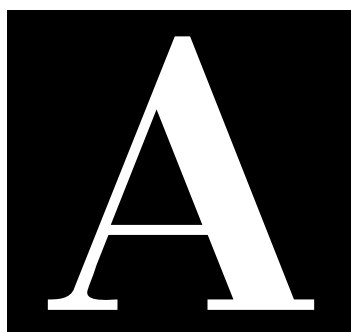

KATALOG /
CATALOGUE
2024

TRADITION & INNOVATION



Gegründet von / Foundet by
Claus Michael Hellfritz

1985 /

The World's Safest Hair Dryer

1990 / The PRO

Haartrockner mit einem Pistolen-Holster-Design /
1st pistol holster design

1993 / Biltmore Collection

Globale inspirierte Kosmetikspiegel /
Globally inspired cosmetic mirrors

1996 / Bad-Accessoires/
Bathroom Accessories

Hotelperfektion
Klares Design, definierte Funktionen /
Clean designs/defined functions

2002 / LED Spiegel/Mirrors

Klassisch inspiriert und elegant effizient /
Classically inspired and elegantly efficient

2012 / China-Büro/Office

Aliseo eröffnet Büro in Shanghai /
Aliseo opens Shanghai office

2015 / Neuer Hauptsitz /
New Headquarters

Umzug nach Gengenbach /
Relocates to Gengenbach

2018 / German Design Award

Ausgezeichnet für hervorragendes Pro-
duktdesign /
Received for excellence in product
design

2020 / NU finishes

Eine unendliche Vielfalt an PVD-Farben
und -Oberflächen /
An endless variety of PVD colors and
finishes



NINA HELLFRITZ-LANGE UND JAN HELLFRITZ
Blicken mit dem Wissen der Vergangenheit in die Zukunft /
Looking to the Future with the Knowledge of the Past



ALISEO

ALISEO
ALISEO
ALISEO

ALISEO

A NEW CULTURE OF HOSPITALITY

Seit über 35 Jahren steht ALISEO an der Spitze einer neuen Kultur der Gastfreundschaft. Eine Evolution traditioneller Formen, bei der die effiziente Neuerfindung von Luxus ein ästhetisches Refugium für den Genuss des Gastes schafft. Modische Lösungen, deren stilistische und geometrische Vielfalt einen Raum in ein Statement des persönlichen Designs verwandelt.

Aliseo bietet technologische Innovation und hochmoderne Ästhetik für eine anspruchsvolle Klientel, die in ihrem Design die Exklusivität ihrer Identität findet. Aliseo verbindet zeitgenössisches Aussehen mit traditionellen Werten und versteht die Integrität und Beziehungen verschiedener Materialien, die Klarheit des Zwecks mit utilitaristischer Schönheit zu verbinden.

Die global inspirierten Produkte von Aliseo führen den Hotelier in eine neue Welt der Gestaltungsmöglichkeiten und bieten mehr Flexibilität, ästhetische Leistung und Designfreiheit. Während einige Kontraste stark sind, ist das Gefühl rhythmisch, dynamisch und faszinierend.

Wir heißen Sie in unserer Welt willkommen. /

For over 35 years ALISEO has been at the forefront of a New Culture of Hospitality. An evolution of traditional shapes and forms where the efficient reinvention of luxury creates an aesthetic refuge for the enjoyment of the guest.

Fashionable solutions whose stylistic and geometric diversity transforms a room into a statement of personal design.

Aliseo offers technological innovation and cutting-edge aesthetics to a demanding clientele who finds in its design the exclusiveness of their identity. A stunning display of contemporary looks and traditional values, Aliseo understands the integrity and relationships of different materials that combine clarity of purpose with utilitarian beauty.

Aliseo's globally inspired products take the hotelier to a new world of design possibilities offering greater flexibility, aesthetic performance and design freedom. While some contrasts are powerful, the feeling is rhythmic, dynamic and intriguing.

We Welcome You to Our World.

Aus dem Schwarzwald - wo Qualität und Handwerkskunst noch Tradition haben /
From Germany's Black Forest - where quality and craftsmanship are still a tradition

LET'S TALK ABOUT WHITE

Ein Blick nach vorne - Aliseo Trends 2024 A look ahead - Aliseo Trends 2024

Als Designunternehmen läuft Aliseo Trends nicht hinterher, sondern es ist uns ein Anliegen am Puls der Zeit zu sein, Wegbereiter und vielleicht auch manchmal Trendsetter. Dafür muss man seine Welt mit offenen Augen erfahren und die Trends und ihre Entwicklung praktisch erspüren. Also strecken wir mal unsere Fühler aus...

In den letzten Jahren manifestierte sich in den Badezimmern der Hang zu schwarzen Accessoires. Nicht zuletzt, weil sie ein schöner Kontrast zu hellen Fliesen und Wänden sind, die den Trend zusammen mit zarten Pastelltönen bestimmten. Das haben wir schon früh erkannt und im Accessoire-Bereich mit NEXXUS die schwarze Schwester unserer erfolgreichen NOW-Serie auf den Markt gebracht. Mit umwerfendem Erfolg. Immer mehr kommen inzwischen aber starke Farben zurück in unsere Räume. Und die benötigen eher ein ausgleichendes Pendant. Was läge also näher, als diese mit weißen Elementen zu unterstreichen?

Im Sortiment gibt es daher inzwischen unsere ultramoderne MAXIMA-Serie neben Schwarz auch in Weiß. Trendsetting sozusagen. Aber nicht alle sind bereit für kompromisslos boldes Design. Macht nix. Denn alle Serien und Kosmetikspiegel lassen sich ja mit unseren NU finishes in unzähligen Farben gestalten. Und natürlich auch in Weiß. Wie wäre es zum Beispiel mit der zeitlosen NOW in matt Weiß? Ganz schön schön...

As a design company, Aliseo does not chase trends, but is committed to keeping its finger on the pulse of the times, paving the way and perhaps sometimes even setting trends. To do this, you have to experience your world with open eyes and practically sense the trends and their development. So let's put out our feelers...

In recent years, the trend towards black accessories has manifested itself in bathrooms. Not least because they provide a beautiful contrast to the light-colored tiles and walls that set the trend together with delicate pastel shades. We recognized this early and launched NEXXUS, the black sister of our successful NOW series, in the accessories range. With stunning success. However, strong colors are now increasingly returning to our rooms. And they need a balancing counterpart. So what could be more obvious than to emphasize them with white elements?

That's why our ultra-modern MAXIMA range is meanwhile available in white as well as black. Trendsetting, so to speak. But not everyone is ready for uncompromisingly bold design. No matter. Because all series and cosmetic mirrors can be designed in countless colors with our NU finishes. And in white too, of course. How about the timeless NOW in matt white, for example? Quite beautiful...



NU FINISHES
A PERFECT
MATCH



NU finishes
ALISEO
GERMANY



Ein abstrakter Name für eine kleine Revolution. Doch was steckt dahinter?

Eine Spurensuche..

Die Anforderungen im Hospitality-Sektor steigen von Jahr zu Jahr und werden immer komplexer. Es geht nicht mehr nur darum einladende Häuser mit gutem Service zu bewirtschaften, sondern sich als Marke klar zu positionieren, Besucher zu Fans zu machen, und im besten Fall auch die Fragen unserer Gesellschaft zu beantworten. Eine Mammutaufgabe, der man kaum gewachsen sein kann.

Also haben wir uns die Frage gestellt, wie wir unsere Kunden und langjährigen Partner bestmöglich bei Ihren Herausforderungen unterstützen können. Unsere Antwort ist auch heute noch die gleiche wie 2017, als wir sie erstmalig vorstellten – NU finishes. /

An abstract name for a small revolution. But what is behind it?

A search for clues..

The requirements in the hospitality sector are increasing from year to year and are becoming ever more complex. It's no longer just about managing inviting hotels with good service, but also about positioning yourself clearly as a brand, turning visitors into fans and, preferably, answering the questions of our society. A mammoth task that is almost impossible to cope with.

So we asked ourselves how we could best support our customers and long-standing partners with their challenges. Our answer is still the same today as it was when we first introduced it in 2017 - NU finishes.

Kurz gesagt, ein Service, der es möglich macht, alle Artikel aus den Aliseo Accessoire-Serien sowie alle Kosmetikspiegel frei in Farbe und Oberfläche zu gestalten. Ohne Mindestmenge. Jede Farbe ist möglich. Individualisierung deluxe.

Möglich wird das durch PVD-Beschichtung. Ein physikalisches Verfahren, bei dem die Farbpigmente unter hoher Temperatur verdampfen und sich durch elektrische Ladung dauerhaft mit der Oberfläche verbinden. Die Vorteile sind mannigfaltig: eine hohe Farbtreue und Festigkeit sowie keine unnötigen Farbabfälle in der Produktion.

Das wir dabei keine Abstriche bei der Qualität machen, versteht sich von selbst. Das ist für Aliseo nicht nur Ehrensache, sondern gelebte Nachhaltigkeit. Und die wollen wir noch weiter unterstreichen und bieten, soweit möglich, Ersatzteile für alle unsere Produkte an. /

In short, a service that makes it possible to design all items from the Aliseo accessory series as well as all cosmetic mirrors in any color and surface. No minimum quantity. Any color is possible. Individualization deluxe.

This is made possible by PVD coating. A physical process in which the color pigments evaporate under high temperature and permanently bond with the surface through an electrical charge. The advantages are manifold: high color fidelity and strength as well as no unnecessary color waste during production.

It goes without saying that we do not compromise on quality. For Aliseo, this is not just a matter of honor, it is sustainability in action. And we want to emphasize this even further by offering spare parts for all our products wherever possible.



ARCHITECTO
goldoptik 203/ gold optic 203



Die Vorteile liegen auf der Hand: hohe Farbbrillanz und besonders gleichmäßiger Farbauftrag ohne Durchscheinen des Metalls. Die dauerhafte physikalische Verbindung von Werkstück und Beschichtung sorgt für eine Oberfläche, die nicht nur besonders langlebig ist, sondern auch kratzfest, korrosionsbeständig und leicht zu reinigen. Egal ob matt, poliert oder gebürstet. Sie haben die Wahl./

The advantages are obvious: high color brilliance and particularly even color application without the metal showing through. The permanent physical bond between workpiece and coating ensures a surface that is not only particularly durable, but also scratch-resistant, corrosion-resistant and easy to clean. Whether matt, polished or brushed. The choice is yours.

NU finishes sind in einer nahezu unbegrenzten Auswahl an Farben und Oberflächen erhältlich. Die PVD-Beschichtung ermöglicht individuelle Metalloberflächen auf Basis eines Musters, aber ebenso in schwarz oder weiß. Dafür senden Sie uns das Muster eines Artikels, an dem die Farbe ausgerichtet werden soll. Die Farbwerte werden dann bei uns ausgelesen und für die Beschichtung als Grundlage genommen. So können Sie sicher sein, dass alle Bad-Accessoires und Kosmetikspiegel von Aliseo perfekt zu Armaturen oder Wandspiegeln passen../

NU finishes are available in an almost unlimited selection of colors and surfaces. The PVD coating enables individual metal surfaces based on a sample, but also in black or white. To do this, you send us the sample of an article on which the color is to be matched. The color values are then read out by us and used as the reference for the coating. This way, you can be sure that all bathroom accessories and vanity mirrors from Aliseo match perfectly with fittings or wall mirrors.



Und weil wir von unserer Qualität überzeugt sind, geben wir 10 Jahre Garantie auf alle Chromoberflächen und 5 Jahre Garantie auf alle PVD-Beschichtungen. Bitte beachten Sie dazu unsere Pflegehinweise./

And because we are convinced of our quality, we give a 10-year guarantee on all chrome surfaces and a 5-year guarantee on all PVD coatings. Please refer to our care instructions.

LED SATURN
rotgold 209 / red gold 209



COSMO MINIMALIST
schwarz / black

Die beliebtesten metallischen Farben haben wir für Sie in einer Standardpalette zusammengestellt. Jeweils in poliert oder gebürstet.
 Dabei haben wir uns auch an den gängigen Oberflächenfarben namhafter Sanitärhersteller orientiert. Perfect Match eben..

We have compiled the most popular metallic colors for you in a standard palette. Polished or brushed.
 We have also used the standard surface colors of well-known sanitaryware manufacturers for reference. A perfect match.

POLIERT / POLISHED



GEBÜRSTET / BRUSHED



Bitte beachten Sie, dass Farbabweichungen im Druck technisch bedingt sind und vorkommen können. Falls Sie an einer bestimmten Standardfarbe interessiert sind, bestellen Sie gerne ein Farbmuster oder sprechen Sie mit unseren Experten..

Please note that color variations in printing are due to technical reasons and may occur. If you are interested in a specific standard color, please order a color sample or contact our experts.



Alle Artikel, bei denen das Symbol der NU finishes zu finden ist, kann mit Wunschoberfläche gestaltet werden..

All items with the NU finishes symbol can be designed with the individual finish of your choice.



LED MOON DANCE
Messing 206 /
brass 206



LED INTERFACE
Nickel gebürstet 307/
brushed nickel 307

Messing 206/
brass 206

chrom 100/
chrome 100



NU finishes

NU finishes – so funktioniert's NU finishes - here's how it works



NU finishes

1. Anfrage/Angebot: inquiry/offer:

Wir erstellen Ihnen ein erstes Angebot mit Zeitplan
We will provide you with an initial offer with a schedule

- Um welche Artikel geht es?
Which items are you interested in?
- Welche Stückzahlen?
What quantities?
- Wie ist der zeitliche Ablauf bis zum gewünschten Lieferdatum?
What is the timeline until the desired delivery date?
- In welchem Rahmen liegt das Budget?
What is the budget?
- Um welches Projekt handelt es sich?
Which project is involved?

2. Wunschfarbe aussuchen: select your favored color:

- Wählen Sie aus unseren Standardfarben oder
Choose from our standard colors or
- Nennen Sie uns den Farbcode des Herstellers, dessen Farbe als Basis dienen soll oder
Tell us the color code of the manufacturer whose color is to serve as the reference or
- Senden Sie uns ein Muster als Farbreferenz
Send us a sample as a color reference
- Welche Oberflächenveredelung soll es sein? Matt, poliert oder gebürstet?
Which surface finish do you require? Matt, polished or brushed?



3. Musterproduktion/Mock-up: sample production/mock-up:

- Wir fertigen den Artikel Ihrer Wahl in Ihrer Wunschfarbe für den Mock-up-Room
We produce the item of your choice in your required color for the mock-up room
- Produktionszeit 6-8 Wochen
Production time 6-8 weeks
- Keine zusätzlichen Kosten. Sie bezahlen nur den Artikel mit Sonderfarbe zum Selbstkostenpreis.
No additional costs. You only pay for the item with the custom color at cost price.
- Wenn es mal schnell gehen muss, haben wir alle Artikel in Chrom auf Lager. Schwarz nach Verfügbarkeit.
If time is of the essence, we have all items in chrome in stock. Black subject to availability.



4. Bestellung: order:

- Festlegung des Zeitplans
Determining the schedule
- Die Lieferzeit liegt bei 15-18 Wochen
The delivery time is 15-18 weeks



5. Lieferung: delivery:

- Wir liefern pünktlich zum bestätigten Lieferdatum weltweit
We deliver on time on the confirmed delivery date worldwide
- Schnellere Lieferung nötig? Sprechen Sie uns an!
Need faster delivery? Get in touch with us!



6. Aftersales:

- Profitieren Sie von der Aliseo Garantie auf Oberflächen von 5 - 10 Jahre
Benefit from the Aliseo guarantee on surfaces from 5 - 10 years
- Auch noch Jahre später lässt sich Ihre individuellen Farben reproduzieren und Nachbestellungen sind gesichert
Your individual colors can still be reproduced years later and reorders are guaranteed



ARCHITECTO
goldoptik 203 / gold optic 303

ARCHITECTO
chrom 100 / chrome 100

INHALT



CONTENT

HOTEL-HAARTROCKNER / HAIR DRYERS	22-53
Black Mambo 1875	28-31
Polarfox 1875	32-35
Carbonic 1900	36-39
Chromo	40-43
Air 1800	44-45
Phoenix	46-47
Pro	48-49
KOSMETIKSPIEGEL / COSMETIC MIRRORS	54-95
LED Moon Dance	58-63
LED Saturn	64-65
LED Interface	66-69
LED Cubik	70-73
LED Vision	74-75
LED Lunatec	76-77
LED City Light	78-79
LED ME	80-81
LED MY	82-83
Cosmo Minimalist	84-85
FACE	86-87
FACE plus	88-89
Concierge Collection	90-91
HOTELBAD-ACCESSOIRES / BATHROOM ACCESSORIES	96-157
Architecto	98-103
Tecno	104-111
Now	112-117
Nexus	118-123
Maxima	124-131
Complementary	136-143
Badezimmerhocker / Bathroom Stools	144-145
Personenwaagen / Scales	146-149
Hygieneeimer / Waste Bins	150-157
GÄSTEZIMMER / GUESTROOM	158-205
Wasserkocher / Water Kettles	160-167
Tablett-Sets / Tablet Sets	168-171
Leder Accessoires / Leather Accessories	172-201
Kofferablagen / Luggage Racks	202-205
BÜGELSTATIONEN / IRONING STATIONS	206-225
Bügeleisen / Irons	208-211
Bügelstationen / Ironing Centers	212-225

HAARTROCKNER
HAIR DRYER



Engineered for Excellence

Aliseos neueste Generation von Luxus Performance Haartrocknern ist das Zusammenspiel aus italienischem Feingefühl für Formsprache und Aliseos kompromisslose, technische Standards in Bezug auf Technik und Langlebigkeit. Wahlweise in verschiedenen Farben und Oberflächen ergeben sich eine Vielzahl von Einsatz- und Kombinationsmöglichkeiten. Alle Modelle sind auch zur festen Wandmontage mit Direktanschluss erhältlich. /

Our new line of Luxury Performance Hair Dryers has incorporated the essence of Italian design with the rigorous demands of Aliseo engineering. Engineered for maximum air flow, minimum weight, low vibration and extended life. Peerless performance and drying efficiency is enhanced by a high speed motor assembly and an on-board Ion emitter that decreases drying time and locks in moisture for a healthier gentler drying experience. Available in an attractive array of different colors and finishes. With a choice of holders for hard wire installations.

Luxury Performance

hair

Dryers



PERFORMANCE BY DESIGN



IONIC TECHNOLOGY

"Trocknet das Haar ohne es auszutrocknen!"

Eine schonende und effiziente Trocknungsmethode, die die Feuchtigkeitsbalance wieder herstellt, die Nährstoffe einschließt und die Haaroberfläche versiegelt.

Benötigt **30% weniger Energie und 50% weniger Trocknungszeit!** /

"Dries Hair without Drying It Out!"

Ionic Technology is a gentler more efficient drying method that restores moisture balance: locking-in natural nutrients.

Requires **30% less energy and 50% less drying time!**

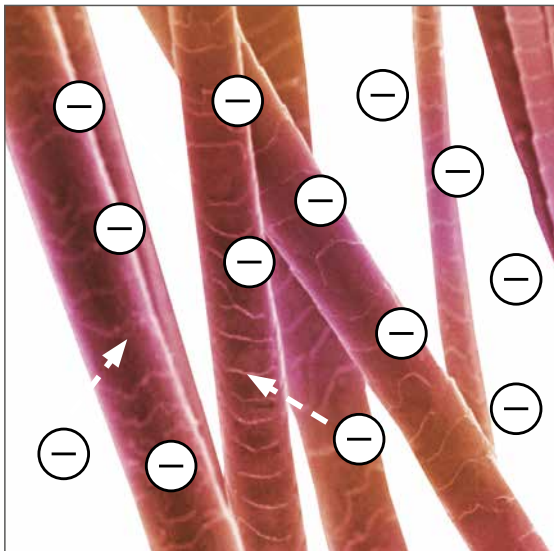

Erzeugung negativer Ionen, die die Wassermoleküle aufbrechen und die Feuchtigkeit tief in das Haar eindringen lassen. Ionen verschließen die Schutzschicht; die Feuchtigkeit wird bewahrt. Die Haaroberfläche wird geglättet und versiegelt, Feuchtigkeit und Nährstoffe bleiben im Haar. /

Converts air stream into negative ions that break large water drops into smaller droplets. Moisture is evaporated gradually locking in nutrients for a healthier, shinier fuller body of hair.

IONEN-TECHNOLOGIE

- Negative Ionen im Luftstrom wandeln positive Teilchen um, keine elektrostatische Aufladung.
- Ionen brechen die Wassermoleküle auf.
- Haaroberfläche wird geglättet und versiegelt, Feuchtigkeit und Nährstoffe bleiben im Haar.
- Feuchtigkeitsgleichgewicht im Haarfollikel wird wieder hergestellt.
- Eine sanfte und schonende Trocknungsmethode, die 30 % weniger Hitze und 50 % weniger Zeit benötigt.

IONIC TECHNOLOGY

- Converts air stream into negatively charged ions – no electrostatic charge.
- Negative ions break large droplets into much smaller water droplets.
- Smaller water droplets are more quickly absorbed into the hair – hair is dried quicker.
- Ions seal the outer coating of the hair follicle locking in nutrients.
- Adds a conditioning effect as moisture balance is restored.



- Gleichmäßige Wärmeverteilung durch konzentrische Spiralheizung
- Integrierter Ionen-Generator verkürzt die Trocknungsdauer und schützt die Haare vor dem Austrocknen. /
- Concentric Heating Coil Secures Even Heat Distribution
- Integrated Ion Emitter - Locks in Moisture And Lessens Drying Time.

- Austauschbarer Haarfilter /
- Removable E-Z Care Hair Filter

- Mehrere Temperatur- und Gebläsestufen für ein professionelles Styling /
- Cold-Shot Function with Multiple Heat/Speed Settings For Maximum Styling

- Optimiertes Lüfterrad für maximale Luftleistung
- Leistungsstarker Hochgeschwindigkeitsmotor /
- Turbo Blade Fan Design Ensures High Volume Air Flow
- Professional High-Speed Motor Assembly

- „Air-Tec“ Düse erhöht Luftleistung
- Ausziehbares 60 cm Spiralkabel
- Inkl. Tasche zur Aufbewahrung in Schublade /
- Air-Tec-Nozzle Increases Air Flow
- Durable 60 cm. Expandable Coil Cord
- Convenient Draw-String Storage Bag

- Angenehme Bedienung der Schaltstufen in der Mitte des ergonomischen Griffes
- Ausgeglichener Schwerpunkt für leichtere Handhabung /
- Comfortable Contoured Handle With Center Controls
- Gravitationally Balanced Weight Distribution For Easier Handling

TECHNOLOGY MEETS DESIGN

Elegante kraftvolle Formen mit zeitlosem Profil kombinieren unvergleichliche Leistung mit Trocknungseffizienz /
Elegantly powerful lines within a contemporary profile combine peerless performance and drying efficiency.

Unsere Haartrockner sind auf Anfrage mit zusätzlichem Kabel und Stecker zum Anschluss an die Steckdose erhältlich /
Our hair dryers are available with additional cord and plug for plug-in application on request.



BLACK MAMBO 1875

Die besondere Easy-Touch Komfortbeschichtung ist verführerisch weich und angenehm. Der leistungsstarke Motor und die Temperaturstufen können individuell eingestellt werden. Integrierte Ionentechnologie verkürzt den Trocknungsprozess, spart Energie und schützt das Haar vor dem Austrocknen - für ein professionelles Styling wie beim Frisör. /

EZ touch comfort coating with anti-slip protection in a distinctive matt black finish.

Ergonomic housing incorporates high performance motor assembly, Ionic functions and multiple speed controls for the ultimate in professional styling.



01



Easy-Touch Komfortbeschichtung
in schwarz mattem Finish /
EZ Touch Comfort Coating in a
distinctive matt black finish

02



mit Stecker /
plug in



Für die Schublade /
Drawer Solution

BLACK MAMBO

Ionen-Technologie
Drei Temperaturstufen
Zwei Gebläsestufen
Kaltlufttaste
AC-Motor
Abnehmbare Düse
Überhitzungsschutz
Doppelte Isolierung
Schutzklasse II
Spiralkabel, 60 cm

Ionic technology
Three heat settings
Two air speeds
Cold shot button
AC motor
Removable nozzle
Overheating protection
Double insulation
Class II
Coil cord, 60 cm



220-240 V, 50/60 Hz, Cool / 900 / 1875 W

Ohne Halterung. Mit Aufbewahrungstasche
Mit Stecker zum Anschluss an Steckdose /
Without holder. With storage bag
With plug for plug-in application

010492

schwarz, Easy-Touch /
black, EZ touch

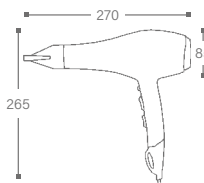

01. Easy-Touch-Komfortbeschichtung für angenehme Handhabung / EZ touch comfort coating with anti-slip protection.
02. Mehrere Schaltstufen & Kaltlufttaste / Variable speed & cold shot controls



HANG-UP



- 03. Einfaches Einhängen. Integrierte Gelpads verhindern Kratzer / Hang-up cradle design with gel pad protection
- 04. Langlebiger 1875 Watt AC-Motor / 1875 Watt long-life AC-motor

Wandhalterung mit Netztrennschalter
Direktanschluss /
Wall holder with interrupter switch
Hard wired application

010596 schwarz, Easy-Touch /
black, EZ touch

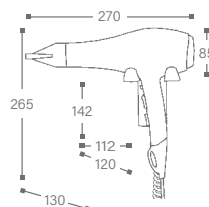



DROP-IN

- 05. Einfaches Einhängen /
Easy Drop-In Design
- 06. Integrierter Silikonring verhindert Kratzer /
Rubber insert guards against scratches
and wear and tear

DROP-IN

Praktische Designhalterung DROP-IN mit Kratzschutz und beleuchtetem Netztrennschalter für zusätzliche Sicherheit. /
Convenient drop-in holder with rubber snug-fit insert to protect against scratches and wear and tear. Illuminated interrupter switch guards against circuit leakage.

Wandhalterung mit Netztrennschalter
Direktanschluss /
Wall holder with interrupter switch
Hard wired application

010598 schwarz, Easy-Touch /
black, EZ touch

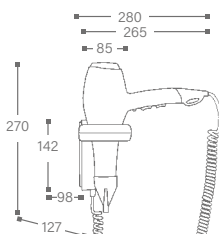





IONIC
TECH

POLARFOX

Ionen-Technologie	Ionic technology
Drei Temperaturstufen	Three heat settings
Zwei Gebläsestufen	Two air speeds
Kaltlufttaste	Cold shot button
AC-Motor	AC motor
Abnehmbare Düse	Removable nozzle
Überhitzungsschutz	Overheating protection
Doppelte Isolierung	Double insulation
Schutzklasse II	Class II
Spiralkabel, 60 cm	Coil cord, 60 cm

CE  220-240 V, 50/60 Hz, Cool / 900 / 1875 W

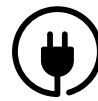

mit Stecker /
plug in



Für die Schublade /
Drawer Solution

Ohne Halterung. Mit Aufbewahrungstasche
Mit Stecker zum Anschluss an Steckdose /
Without holder. With storage bag
With plug for plug-in application

010547

weiß/silber /
white/silver

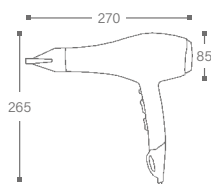

- 01. Langlebiger 1875 Watt AC-Motor /
1875 Watt long-life AC-motor
- 02. Mehrere Schaltstufen und
Kaltlufttaste /
Variable speed and cold shot controls



DROP-IN

- 03. Einfaches Einhängen /
Easy Drop-In Design
- 04. Integrierter Silikonring verhindert Kratzer /
Rubber insert guards against scratches
and wear and tear

Wandhalterung mit Netztrennschalter
Direktanschluss /
Wall holder with interrupter switch
Hard wired application

010549 weiß/silber /
white/silver

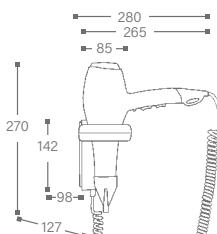



HANG-UP

05. Einfaches Einhängen /
Hang-up cradle design

Wandhalterung mit Netztrennschalter
Direktanschluss /
Wall holder with interrupter switch
Hard wired application

010548 weiß/silber /
white/silver

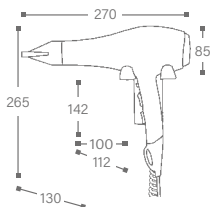





CARBONIC 1900

Perfektion in Karbon, ein optisches Highlight mit ausgereifter Technik. Langlebig, leicht und trotzdem robust. Der leistungsstarke Motor in Verbindung mit den Vorteilen der integrierten Ionentechnik ermöglicht ein professionelles Styling wie beim Frisör. Die Schaltstufen für Temperatur und Gebläse in der Mitte des Griffs lassen sich für Rechts- und Linkshänder gleichermaßen angenehm bedienen. /

A visual alternative to the mainstream. Distinctive carbon optic combines clarity of purpose with utilitarian beauty. Contoured handle with centrally located controls accommodates both left and right hand users. Gravitationally balanced weight distribution maximizes comfort and control.



mit Stecker /
plug in



Für die Schublade /
Drawer Solution

CARBONIC

Ionen-Technologie
Drei Temperaturstufen
Zwei Gebläsestufen
Kaltlufttaste
AC-Motor
Abnehmbare Düse
Überhitzungsschutz
Doppelte Isolierung
Schutzklasse II
Spiralkabel, 60 cm

Ionic technology
Three heat settings
Two air speeds
Cold shot button
AC motor
Removable nozzle
Overheating protection
Double insulation
Class II
Coil cord, 60 cm

Ohne Halterung.
Mit Aufbewahrungstasche
Mit Stecker zum Anschluss an Steckdose /
Without holder. With storage bag
With plug for plug-in application

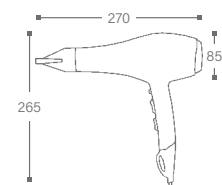

010493

Karbon-Muster /
carbon-pattern



220-240 V, 50/60 Hz, Cool / 950 / 1900 W

CARBONIC 1900



HANG-UP



- 01. Ausführung in Karbonoptik / High gloss Carbonic Optic
- 02. Einfaches Einhängen. Integrierte Gelpads verhindern Kratzer / Hang-up cradle design with gel pad protection
- 03. Austauschbarer Haarfilter / Removable E-Z Care Hair Filter

Wandhalterung mit Netztrennschalter
 Direktanschluss /
 Wall holder with interrupter switch
 Hard wired application

010502 Karbon-Muster /
 carbon-pattern

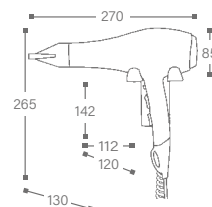



DROP-IN

- 04. Mehrere Schaltstufen und Kaltlufttaste mit Ionenfunktion / Variable speed and cold shot controls
- 05. Einfaches Einhängen / Easy Drop-In Design
- 06. Integrierter Silikonring verhindert Kratzer / Rubber insert guards against scratches and wear and tear

Wandhalterung mit Netztrennschalter
Direktanschluss /
Wall holder with interrupter switch
Hard wired application

010543 **Karbon-Muster /**
carbon-pattern

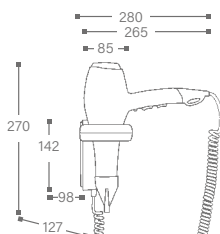





mit Stecker /
plug in



Für die Schublade /
Drawer Solution



Easy-Touch Komfortbeschichtung
in schwarz mattem Finish /
EZ Touch Comfort Coating in a
distinctive matt black finish

CHROMO

Hotel-Sicherheits-Tastenschalter
Zwei Schaltstufen
Abnehmbare Düse
Überhitzungsschutz
Doppelte Isolierung
Schutzklasse II
Spiralkabel, 50 cm

Hotel safety switch
Two heat/speed settings
Removable nozzle
Overheating protection
Double insulation
Class II
Coil cord, 50 cm

CE 220-240 V, 50/60 Hz 600 / 1200 W

Ohne Halterung
Mit Stecker zum Anschluss an Steckdose /
Without holder
With plug for plug-in application

010437 chrom/schwarz, Easy-Touch / 
chrome/black, EZ touch

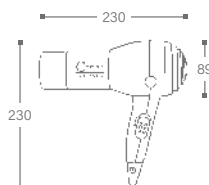

- 01. Mit schmaler Düse für exaktes Styling /
Narrow air concentrator for
pinpoint styling
- 02. Mehrere Schaltstufen /
Variable speed
- 03. Easy-Touch-Komfortbeschichtung /
EZ touch comfort coating
- 04. Komfortabler, rutschfester
Handgriff /
Comfortable ribbed anti-slip handle



Mit Ringhalterung.
Spiralkabel mit Stecker. /
With ring holder.
Coil cord with plug.

010330 chrom/schwarz /
chrome/black

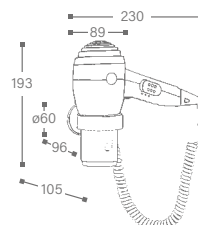



- 01. Wandhalterung, Messing, verchromt
Montage mit Diebstahlschutz /
Wall holder, brass, chrome plated
Wire-thru anti-theft protection
- 02. Netztrennschalter /
Safety security switch
- 03. Lieferung mit schmaler Düse für exaktes
Styling /
Comes with narrow air nozzle for pinpoint
styling
- 04. Gummierter Innenring zum Schutz /
Rubber inner-ring scratch protection
- 05. Design-Halterung mit Kratzschutz /
Low profile holder

Wandhalterung mit Netztrennschalter.
Direktanschluss. /
Wall holder with interrupter switch.
Hard wired.

010407 chrom/schwarz /
chrome/black

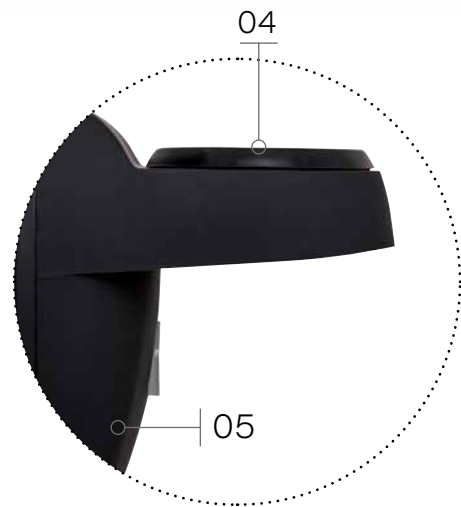
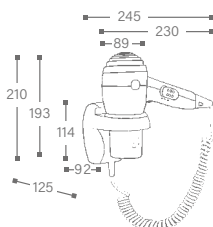



Eine preiswerte Alternative.

Der AIR 1800 zeichnet sich durch maximalen Luftstrom und sehr geringes Gewicht aus.

Mehrere Temperatur- und Gebläsestufen im sicherem Griff maximieren den Bedienkomfort Ihrer Gäste.

Modernes Profil mit sicherem Griff und pflegeleichtem Luftfilter. /

An economic professional alternative.

The AIR 1800 was engineered for absolute minimum weight and maximum air flow. Multiple settings and sure-grip handle maximizes your guest's comfort and drying control.

Contemporary profile with sure-grip handle and E-Z care mesh filter.





AIR 1800

Drei Temperaturstufen
 Zwei Gebläsestufen
 Kaltlufttaste
 DC-Motor
 Abnehmbare Düse
 Überhitzungsschutz
 Doppelte Isolierung
 Schutzklasse II
 180 cm langes, glattes Kabel

Three heat settings
 Two air speeds
 Cold shot button
 DC motor
 Removable nozzle
 Overheating protection
 Double insulation
 Class II
 180 cm straight cord

Ohne Halterung.
 Mit Aufbewahrungstasche und Klett-Kabelbinder
 Glattes Kabel und Stecker
 zum Anschluss an Steckdose /
 Without holder. With storage bag and velcro cable tie
 With plug for plug-in application

010568 schwarz / black 

 220-240 V, 50/60 Hz

Cool / 900 / 1800 W

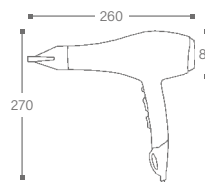



PHOENIX - A modular design

Die modulare Wandhalterung wird allen Anforderungen von Hotelier und Gast gerecht. EcoSmart Design - Maximaler Air Flow durch speziell entwickeltes Lüfterdesign. EcoSmart 1200 W Heizelement optimiert die Erhitzung der Luft und somit die Effizienz des Trocknungsprozesses. /

Modular holder designs meet the various different needs of today's hotelier and their guests. EcoSmart Heating Chamber Design - High-speed pitched blade fan produces a high volume air flow propelling the air rapidly across a sealed heating grid. EcoSmart 1200 W, "Honeycomb" heating element maximizes the heating of the air and the overall efficiency of the drying process.

Hotel-Sicherheits-Tastschalter / Hotel safety switch
 Zwei Schaltstufen / Two heat/speed settings
 Überhitzungsschutz / Overheating protection
 Doppelte Isolierung / Double insulation
 Schutzklasse II / Class II
 Spiralkabel, 40 cm / Coil cord, 40 cm

Einfaches Einhängen.
 Gelpads verhindern Kratzer.
 Modulare Wandhalterung mit
 Netztrennschalter /
 Hang-up cradle design
 with gel pad protection.
 Modular holder design with
 interrupter switch

PHOENIX - R

Rasiersteckdose 110-220 V max. 20 VA
 Wandhalterung mit Netztrennschalter
 Direktanschluss /
 Shaver socket 110-220 V max. 20 VA
 Wall holder with interrupter switch
 Hard wired application

010225
 weiß/grau / white/grey

010308
 chrom/schwarz / chrome/black

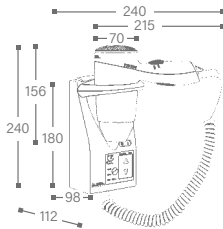

COLOR OPTIONS

weiß/grau /
 white/grey



chrom/schwarz /
 chrome/black



**PHOENIX
010235**

Ohne Halterung
Mit Stecker zum Anschluss an Steckdose
weiß/grau /
Without holder
With plug for plug-in application
white/grey

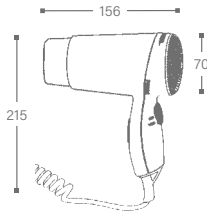

**PHOENIX - B
010213**

Wandhalterung mit Netztrennschalter
Direktanschluss
weiß/grau /
Wall holder with interrupter switch
Hard wired application
white/grey

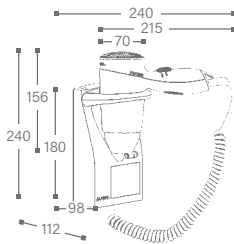

**PHOENIX - S
010221**

Schukosteckdose
220-250 V / 16 A / 3600 W
Wandhalterung mit Netztrennschalter
Direktanschluss.
weiß/grau /
Schuko socket
220-240 V / 16 A / 3600 W
Wall holder with interrupter switch
Hard wired application
white/grey

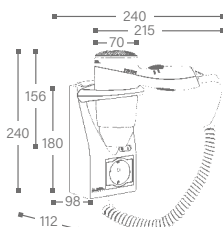



PRO
The Original



PRO

Hotel-Sicherheits-Tastschalter
Eine Schaltstufe
Überhitzungsschutz
Doppelte Isolierung
Schutzklasse II
Spiralkabel, 40 cm

Hotel safety switch
One heat/speed setting
Overheating protection
Double insulation
Class II
Coil cord, 40 cm

* Dauerhaft, ökonomisch & effizient
Mehr als 500.000 Installationen auf
6 Kontinenten haben seinen legendären
Ruf begründet /
Reliable, economic & efficient
A 20 year track record with
over 500,000 installations on
6 continents

CE 220-250 V, 50/60 Hz 1200 W

Wandhalterung mit Netztrennschalter
Direktanschluss /
Wall holder with interrupter switch
Hard wired application

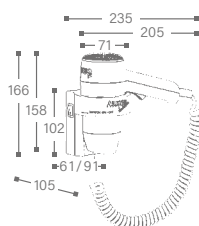

010001 weiß/schwarz /
white/black

TECHNISCHE DATEN / TECHNICAL DETAILS

Alle Haartrockner:

Überhitzungsschutz
Doppelte Isolierung
Schutzklasse II
*1 110 V auf Anfrage
*2 Auch lieferbar mit zusätzlichem
Kabel und Stecker zum Anschluss
an Steckdose

All Hair Dryers:

Overheating Protection
Double Insulation, Class II
*1 110 V upon request
*2 Also available with additional
cord and plug for plug-in
application



CARBONIC 1900
Karbon-Muster
carbon-pattern

BLACK MAMBO 1875
schwarz
black

POLARFOX 1875
weiß/silber
white/silver

Trocknungstechnologie Drying Technology	Ionentechnologie Ionic Technology	Ionentechnologie Ionic Technology	Ionentechnologie Ionic Technology
Besondere Merkmale Special Features		Soft-Touch-Lackierung Rubberized Coating	
Hotel-Sicherheits-Tastschalter Hotel Safety Switch			
Kaltlufttaste Cold Shot Button	■	■	■
Schaltstufen / Wattage Heat/Speed Settings / Wattage	3: Cool / 950 / 1900 W	3: Cool / 900 / 1875 W	3: Cool / 900 / 1875 W
Zusätzliche Gebläsestufen Additional Speed Settings	2	2	2
AC-Motor AC Motor	■	■	■
Halterung mit Netztrennschalter Holder with Interrupter Switch	■	■	■
Direktanschluss Hard Wired	■ *2	■ *2	■ *2
Anschluss an Steckdose Plug-in Application			
Spiralkabel Länge normal / gedehnt Coil Cord Length regular / stretched	60 cm / 150 cm	60 cm / 150 cm	60 cm / 150 cm
Temperatur / Luftstrom / Lautstärke Temperature / Air Flow / Noise Level	74°C / 105 m³/h / 72 dB(A)	74°C / 105 m³/h / 72 dB(A)	74°C / 105 m³/h / 72 dB(A)
Spannung / Frequenz Voltage / Frequency	220-240 V / 50/60 Hz *1	220-240 V / 50/60 Hz *1	220-240 V / 50/60 Hz *1
Prüfzeichen Approvals	CE G	CE G	CE G

Alle Haartrockner:

Überhitzungsschutz
Doppelte Isolierung
Schutzklasse II
*1 110 V auf Anfrage
*2 Auch lieferbar mit zusätzlichem
Kabel und Stecker zum Anschluss
an Steckdose

All Hair Dryers:

Overheating Protection
Double Insulation, Class II
*1 110 V upon request
*2 Also available with additional
cord and plug for plug-in
application



CARBONIC 1900
Karbon-Muster
carbon-pattern

BLACK MAMBO 1875
schwarz
black

POLARFOX 1875
weiß/silber
white/silver

Trocknungstechnologie Drying Technology	Ionentechnologie Ionic Technology	Ionentechnologie Ionic Technology	Ionentechnologie Ionic Technology
Besondere Merkmale Special Features		Soft-Touch-Lackierung Rubberized Coating	
Hotel-Sicherheits-Tastschalter Hotel Safety Switch			
Kaltlufttaste Cold Shot Button	■	■	■
Schaltstufen / Wattage Heat/Speed Settings / Wattage	3: Cool / 950 / 1900 W	3: Cool / 900 / 1875 W	3: Cool / 900 / 1875 W
Zusätzliche Gebläsestufen Additional Speed Settings	2	2	2
AC-Motor AC Motor	■	■	■
Halterung mit Netztrennschalter Holder with Interrupter Switch	■	■	■
Direktanschluss Hard Wired	■ *2	■ *2	■ *2
Anschluss an Steckdose Plug-in Application			
Spiralkabel Länge normal / gedehnt Coil Cord Length regular / stretched	60 cm / 150 cm	60 cm / 150 cm	60 cm / 150 cm
Temperatur / Luftstrom / Lautstärke Temperature / Air Flow / Noise Level	74°C / 105 m³/h / 72 dB(A)	74°C / 105 m³/h / 72 dB(A)	74°C / 105 m³/h / 72 dB(A)
Spannung / Frequenz Voltage / Frequency	220-240 V / 50/60 Hz *1	220-240 V / 50/60 Hz *1	220-240 V / 50/60 Hz *1
Prüfzeichen Approvals	CE G	CE G	CE G

Alle Haartrockner:

Überhitzungsschutz
Doppelte Isolierung
Schutzklasse II
*1 110 V auf Anfrage
*2 Auch lieferbar mit zusätzlichem
Kabel und Stecker zum Anschluss
an Steckdose

All Hair Dryers:

Overheating Protection
Double Insulation, Class II
*1 110 V upon request
*2 Also available with additional
cord and plug for plug-in
application



CARBONIC 1900
Karbon-Muster
carbon-pattern
010493



BLACK MAMBO 1875
schwarz
black
010492



POLARFOX 1875
weiß/silber
white/silver
010547



AIR 1800
schwarz
black
010568

Trocknungstechnologie Drying Technology	Ionentechnologie Ionic Technology	Ionentechnologie Ionic Technology	Ionentechnologie Ionic Technology	Ionentechnologie Ionic Technology
Besondere Merkmale Special Features		EZ Touch-Komfortbeschichtung EZ touch comfort coating		
Hotel-Sicherheits-Tastschalter Hotel Safety Switch				
Kaltlufttaste Cold Shot Button	■	■	■	■
Schaltstufen / Wattage Heat/Speed Settings / Wattage	3: Cool / 950 / 1900 W	3: Cool / 900 / 1875 W	3: Cool / 900 / 1875 W	3: Cool / 900 / 1800 W
Zusätzliche Gebläsestufen Additional Speed Settings	2	2	2	2
AC-Motor AC Motor	■	■	■	
Halterung mit Netztrennschalter Holder with Interrupter Switch				
Direktanschluss Hard Wired				
Anschluss an Steckdose Plug-in Application	■	■	■	■
Spiralkabel Länge normal / gedehnt Coil Cord Length regular / stretched	60 cm / 150 cm	60 cm / 150 cm	60 cm / 150 cm	Glattes Kabel, 180 cm Straight Cord, 180 cm
Temperatur / Luftstrom / Lautstärke Temperature / Air Flow / Noise Level	74°C / 105 m³/h / 72 dB(A)	74°C / 105 m³/h / 72 dB(A)	74°C / 105 m³/h / 72 dB(A)	74°C / 105 m³/h / 72 dB(A)
Spannung / Frequenz Voltage / Frequency	220-240 V / 50/60 Hz *1	220-240 V / 50/60 Hz *1	220-240 V / 50/60 Hz *1	220-240 V / 50/60 Hz *1
Prüfzeichen Approvals	CE	CE	CE	CE

Alle Haartrockner:

Überhitzungsschutz
Doppelte Isolierung
Schutzklasse II
*1 110 V auf Anfrage
*2 Auch lieferbar mit zusätzlichem
Kabel und Stecker zum Anschluss
an Steckdose

All Hair Dryers:

Overheating Protection
Double Insulation, Class II
*1 110 V upon request
*2 Also available with additional
cord and plug for plug-in
application



CHROMO
chrom/schwarz
chrome/black
010437



CHROMO
chrom/schwarz
chrome/black
010330



CHROMO
chrom/schwarz
chrome/black
010407

Trocknungstechnologie Drying Technology			
Besondere Merkmale Special Features	EZ Touch-Komfortbeschichtung EZ touch comfort coating	EZ Touch-Komfortbeschichtung EZ touch comfort coating	EZ Touch-Komfortbeschichtung EZ touch comfort coating
Hotel-Sicherheits-Tastschalter Hotel Safety Switch	■	■	■
Kaltlufttaste Cold Shot Button			
Schaltstufen / Wattage Heat/Speed Settings / Wattage	2: 600 / 1200 W	2: 600 / 1200 W	2: 600 / 1200 W
Zusätzliche Gebläsestufen Additional Speed Settings			
AC-Motor AC Motor			
Halterung mit Netztrennschalter Holder with Interrupter Switch			■
Direktanschluss Hard Wired			■ *2
Anschluss an Steckdose Plug-in Application	■	■	
Spiralkabel Länge normal / gedehnt Coil Cord Length regular / stretched	50 cm / 120 cm	50 cm / 120 cm	50 cm / 120 cm
Temperatur / Luftstrom / Lautstärke Temperature / Air Flow / Noise Level	62°C / 90 m³/h / 76 dB(A)	62°C / 90 m³/h / 76 dB(A)	62°C / 90 m³/h / 76 dB(A)
Spannung / Frequenz Voltage / Frequency	220-240 V / 50/60 Hz *1	220-240 V / 50/60 Hz *1	220-240 V / 50/60 Hz *1
Prüfzeichen Approvals	CE	CE	CE

TECHNISCHE DATEN / TECHNICAL DETAILS

Alle Haartrockner:

Überhitzungsschutz
Doppelte Isolierung
Schutzklasse II
*1 110 V auf Anfrage
*2 Auch lieferbar mit zusätzlichem Kabel und Stecker zum Anschluss an Steckdose

All Hair Dryers:

Overheating Protection
Double Insulation, Class II
*1 110 V upon request
*2 Also available with additional cord and plug for plug-in application



PRO
010001 weiß/schwarz
white/black



PHOENIX
010235 weiß/grau
grey white/grey



PHOENIX - B
010213 weiß/grau
white/grey



PHOENIX - S
010221 weiß/grau
white/grey



PHOENIX - R
010225 weiß/grau
white/grey
010308 chrom/schwarz
chrome/black

Trocknungstechnologie Drying Technology					
Besondere Merkmale Special Features				Schukosteckdose Schuko Socket 220-240 V / 16A / 3600 W	Rasiersteckdose Shaver Socket 110-220 V, max. 20 VA
Hotel-Sicherheits-Tastschalter Hotel Safety Switch	■	■	■	■	■
Kaltlufttaste Cold Shot Button					
Schaltstufen / Wattage Heat/Speed Settings / Wattage	1: 1200 W	2: 600 / 1200 W	2: 600 / 1200 W	2: 600 / 1200 W	2: 600 / 1200 W
Zusätzliche Gebläsestufen Additional Speed Settings					
AC-Motor AC Motor					
Halterung mit Netztrennschalter Holder with Interrupter Switch	■		■	■	■
Direktanschluss Hard Wired	■ *2		■ *2	■	■ *2
Anschluss an Steckdose Plug-in Application		■			
Spiralkabel Länge normal / gedehnt Coil Cord Length regular / stretched	40 cm / 120 cm	40 cm / 120 cm	40 cm / 120 cm	40 cm / 120 cm	40 cm / 120 cm
Temperatur / Luftstrom / Lautstärke Temperature / Air Flow / Noise Level	55°C / 95 m³/h / 67 dB(A)	55°C / 95 m³/h / 67 dB(A)	55°C / 95 m³/h / 67 dB(A)	55°C / 95 m³/h / 67 dB(A)	55°C / 95 m³/h / 67 dB(A)
Spannung / Frequenz Voltage / Frequency	220-250 V / 50/60 Hz *1	220-240 V / 50/60 Hz *1	220-250 V / 50/60 Hz *1	220-250 V / 50/60 Hz *1	220-250 V / 50/60 Hz *1
Prüfzeichen Approvals	CE	CE	CE	CE	CE

Die **HAARTROCKNER-GARANTIE** von 2 Jahren gilt nicht für Spa-Anwendungen oder Anwendungen, die eine kontinuierliche Nutzung darstellen können - Friseursalons, etc. Es gelten weiterhin die folgenden Garantiebedingungen: ordnungsgemäße Installation, Pflege und Wartung.

HAARTROCKNERPFLEGE - Verlängerung der Lebensdauer

- Bitte befolgen Sie die entsprechenden Reinigungsanweisungen - Reinigen Sie den Lufteinlass alle 3 Monate oder wenn nötig und reinigen oder ersetzen Sie den Luftfilter nach Überprüfung alle 3 Monate (Black Mambo, Polarfox, Carbonic, AIR).
- Wickeln Sie das Kabel nicht um den Haartrockner.
- Verwenden Sie den Haartrockner nicht, um Kleidungsstücke oder etwas anderes als das Haar zu trocknen.
- Vorsicht vor einer möglichen „heißen“ Düse nach längerem Gebrauch. /

HAIR DRYER WARRANTY of 2 years does not apply for Spa applications or applications that may constitute continuous use – hair salons, etc. Other warranty conditions still apply: proper installation, care and maintenance.

HAIR DRYER CARE – Extend Life Span

- Please follow appropriate cleaning instructions – vacuum the air intake every 3 months or when necessary and cleaning or replacing the air filter after inspection every 3 months (Black Mambo, Polarfox, Carbonic, AIR).
- Do not coil the power cord or wrap it around the dryer.
- Do not use the hair dryer to assist in the drying of garments, shoes or anything other than hair.
- Beware of a possible “hot” nozzle after long usage.

Ihre Sicherheit . . . unser Anliegen / Your Safety . . . Our Concern

Normen und Verordnungen sind und waren für uns nie ein Ärgernis, sondern Teil einer zielgerichteten Konstruktion. Sie dienen der Sicherheit und Ihre Sicherheit ist unser Anliegen. So wurden praktisch alle Produkte von Aliseo so konstruiert, dass sie die Tarifnormen der europäischen Staatengemeinschaft CE erfüllen oder noch speziellere Normen übertreffen.

In keeping with our philosophy of safety, durability and functionality, regulations are never an annoyance for us but are rather guardrails of directed design. Regulations always have to do with safety. Your safety is our concern. Thus virtually all Aliseo products have been engineered to meet or exceed CE requirements as well as when necessary more specialized standards.

Sicherheitsabstände / Installation Safety Distances

Elektrische Anschlüsse müssen von Duschen und Badewannen mindestens 0,60 m (Zone 3) und von Brauseköpfen mindestens 1,20 m entfernt sein. /

Electric appliances must be wired to the electric circuit in a minimum distance of 0,60 m from shower cabins and bath tubs (zone 3) and of 1,20 m from shower heads.

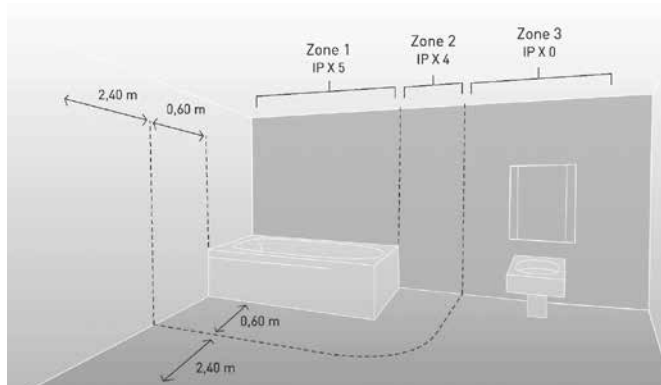

Was Sie über Haartrockner wissen sollten ! / What You Should Know About Hair Dryers !

FI-Schalter

Ein Schalter, der in praktisch alle Badezimmer-Stromkreise eingebaut wird und der das Risiko eines elektrischen Schlages eliminiert, da er sofort den Stromfluss zu allen elektrischen Geräten unterbricht. Seit Mitte der 1980er Jahre, ist der FI-Schalter in fast allen Ländern bei Neubau und Renovierung obligatorisch.

Überhitzungsschutz

Ein Bauteil, das Benutzer sowie Haartrockner schützt, indem es den Haartrockner im Fall einer Überhitzung vorübergehend ausschaltet.

Schutzklasse II - Doppelte Isolierung

Nur Haartrockner mit Schutzklasse 2 sind doppelt elektrisch isoliert und dürfen in Badezimmern installiert werden.

Hotel-Sicherheits-Tastschalter

Der Haartrockner läuft nur, wenn der Schalter gedrückt wird. Sobald man den Schalter loslässt, schaltet der Haartrockner sofort ab. Der Tastschalter bietet zusätzliche Sicherheit, wenn der Haartrockner versehentlich fallen gelassen oder nicht ausgeschaltet wird.

Netztrennschalter

Ein Ein-/Ausschalter an der Wandhalterung, der die gesamte Stromversorgung des Gerätes unterbricht. Eine Sicherheitsanforderung, die in bestimmten Ländern obligatorisch ist.

Schukosteckdose

Ein geerdeter Anschluss für Schutzkontaktstecker.

Rasiersteckdose

Diese Option ermöglicht den Anschluss eines elektrischen Rasierapparates oder das Aufladen eines Mobiltelefons. Bestimmte Haartrockner verfügen über einen Umschalter zum Betrieb bei unterschiedlichen Spannungen - 230 V und 115 V.

Aufbewahrung in Schublade

Besonders geeignet zur Aufbewahrung in einer Schublade.

Direktanschluss

Der Stromanschluss erfolgt direkt in der Wandhalterung. Der Haartrockner wird fest installiert.

Anschluss an Steckdose

Der Haartrockner hat ein Kabel mit Stecker zum Anschluss an eine Steckdose.

FI Switch

A switch installed in the circuitry of virtually all bathrooms that eliminates the risk of electrocution by immediately shutting off the flow of electricity to all appliances. Since the mid 1980's, the FI switch is required in almost all countries in new construction and renovations.

Overheating Protection

A safety feature that protects the user (guests) and the hair dryer by temporarily shutting down the dryer in case of overheating.

Class II - Double Insulation

Only hair dryers with the Class II have double electrical isolation and can be installed in a bathroom. You can identify them by this symbol.

Hotel Safety Switch

The dryer is only activated when the button on the handle is pressed. As soon as the button is released, the dryer immediately shuts off. An added safety feature if accidentally dropped or left on.

Interrupter Switch

An on/off switch on the wall holder that can cut off all power to the unit. A safety feature which is required in many countries.

Schuko Socket

A grounded receptacle for a schuko plug.

Shaver Socket

An optional convenience that is available for shaver sockets or for telephone recharging units. Certain dryers have a built-in transformer that permits both 230 V and 115 V applications.

Drawer Storage

Designed expressly to fit in a drawer.

Hard Wire Application

The hair dryer is wired directly to the electrical source and is fixed with the holder.

Plug-in Application

The hair dryer comes with cord and plug for plug-in application.

KOSMETIKSPIEGEL
COSMETIC MIRRORS





Die revolutionäre T³ Beleuchtung verwendet zwei LED Systeme mit spezifischer weißer/warmweißer Lichtfarbe. Der Gast hat die Option der Farbwahl. Elektrische Komponenten sind im Inneren des Lichtkreises angebracht, um eine schattenfreie Reflexion zu ermöglichen. (Standardausführung bei den Kosmetikspiegeln SATURN, CUBIK und MOON DANCE.) /

Revolutionary T³ lighting utilizes two independent SMD-LED systems with different light emitting pigmentations. Two-Tone-Touch lighting offers the user the choice of a shadow-free brighter daytime look or a warmer more polished night-time appearance. (Standard on SATURN, CUBIK and MOON DANCE mirrors.)

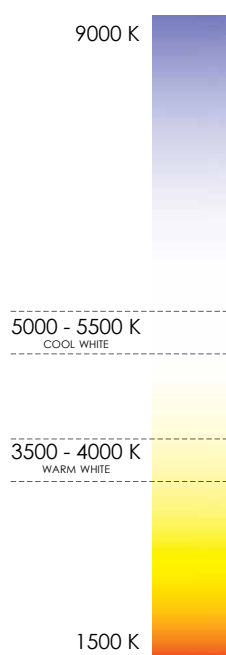

KELVIN FARBSPEKTRUM / KELVIN COLOR SPECTRUM

Da LEDs keine Wärme benötigen, um Licht zu erzeugen, wird deren Farbtemperatur anhand der Lichtfarbe errechnet.

Die Kosmetikspiegel LED INTERFACE, LED CITY LIGHT, LED VISION, LED LUNATEC, LED ME und LED MY haben ein warmweißes Licht von 3500 bis 4000 Kelvin.

Aliseo's T³ Kosmetikspiegel LED SATURN, LED CUBIK und LED MOON DANCE haben zwei Farbtöne, ein warmweißes Licht von 3500 bis 4000 Kelvin und ein kühles weißes Licht von 5000 bis 5500 Kelvin. /

Because LEDs do not use heat to create light, their color temperature is estimated in relation to the color of the light.

Aliseo mirrors LED INTERFACE, LED CITY LIGHT, LED VISION, LED LUNATEC, LED ME and LED MY have a warm white light of 3500 - 4000 Kelvins.

Aliseo T³ mirrors LED SATURN, LED CUBIK, LED MOON DANCE have dual tones a warm white light of 3500 - 4000 Kelvins and a cool white light of 5000 - 5500 Kelvins.

NEW MATERIALS & DESIGNS



Dank der jüngsten Platinentechnik sind inzwischen ultraflache Spiegeldesigns möglich und beflügeln unsere Designs.

Bestes Beispiel ist das Modell LED MOON DANCE vom Designstudio Sieger Design, sowie der LED VISION. Sie beide bestehen durch minimalistische Lichtkörper aus transluzentem Acrylglas mit abgerundeten Kanten und Ambientebeleuchtung.

Wie alle anderen Spiegel, sind sie standardmäßig in verchromter Ausführung bei uns ab Lager verfügbar. Sonderfarben und -ausführungen sind abhängig von der Menge auf Anfrage verfügbar. /

Thanks to the latest circuit board technology, ultra-flat mirror designs are now possible and inspire our designs.

The best example is the LED MOON DANCE model from design studio Sieger Design, as well as the LED VISION. They both impress with minimalist light bodies made of translucent acrylic glass with rounded edges and ambient lighting.

Like all other mirrors, they are available from stock in a chrome finish as standard. Special colors and designs are available on request, depending on the quantity.



Mit den NU finishes gestalten Sie alle Kosmetikspiegel und Badaccessoires in Ihrer Wunschoberfläche und -farbe. Wir setzen diese dann als hochwertige PVD-Beschichtung um. Brillant, langlebig, kratz- und korrosionsbeständig und einfach zu reinigen. /

With NU finishes, you can customize all cosmetic mirrors and bathroom accessories in the surface and color of your choice. We then apply these as a high-quality PVD coating. Brilliant, durable, scratch and corrosion-resistant and easy to clean.



Ambiente Hintergrundbeleuchtung /
Backside ambient lighting



Messing 206 / brass 206

THE ULTIMATE IN COSMETIC CARE

Mit LED Moon Dance by Aliseo hat sieger design eine neue Dimension geschaffen: Die mondartige Aura des Spiegels entsteht durch den transluzenten Acrylkörper, der sein Licht auf subtile Weise, ganzheitlich und in alle Richtungen, entfaltet. Feinste Materialien, minutiöse Oberflächenverarbeitung und eine solide Konstruktion geben Robustheit und Langlebigkeit.

Das lichtdurchlässige Gehäuse aus Acryl sorgt für unverwechselbare ambiente Hintergrundbeleuchtung. Elegante runde Formen, eine weiche Rückenkrümmung sowie eine fein strukturierte Oberfläche simulieren den nächtlichen Himmelskörper./

Developed exclusively for Aliseo by sieger design, the Moon Dance features clean defined lines, new materials and lighting methodologies creating an understated sculptural form of individualized taste and technological seduction. Translucent acrylic housing creates a distinctive backside ambient light.

Circular motif, soft dorsal curvature and smooth textured finish simulate the nocturnal celestial body.

LED MOON DANCE

SMD-LED-Beleuchtung
Warmweißes Licht, 3500-4000 K
Kühles weißes Licht, 5000-5500 K
3-fach-Vergrößerung
High-Tech-Tastschalter
Transluzenter Acryl-Rahmen
Kugelgelenk
Schutzklasse I
100-240 V
Direktanschluss
Messingkonstruktion

SMD-LED-lighting
Warm white light, 3500-4000 K
Cool white light, 5000-5500 K
3x magnification
Hi-tech touch control
Translucent acrylic frame
Full pivotal adjustment
Class I
100-240 V
Hard wire application
Brass construction

IP44



Standmodell
chrom, ø 240 mm /
Free standing
chrome, ø 240 mm
020759

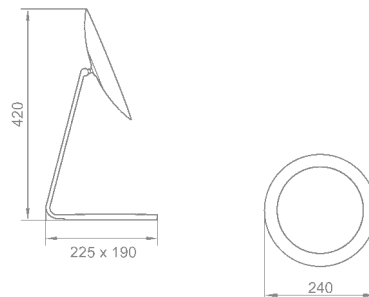

Am Schwenkarm
chrom, ø 240 mm /
On single arm
chrome, ø 240 mm
020758

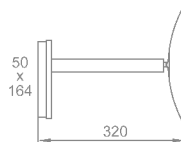

product concept + design: sieger design



LED MOON DANCE

Transluzenter Acryl-Rahmen /
Translucent acrylic housing

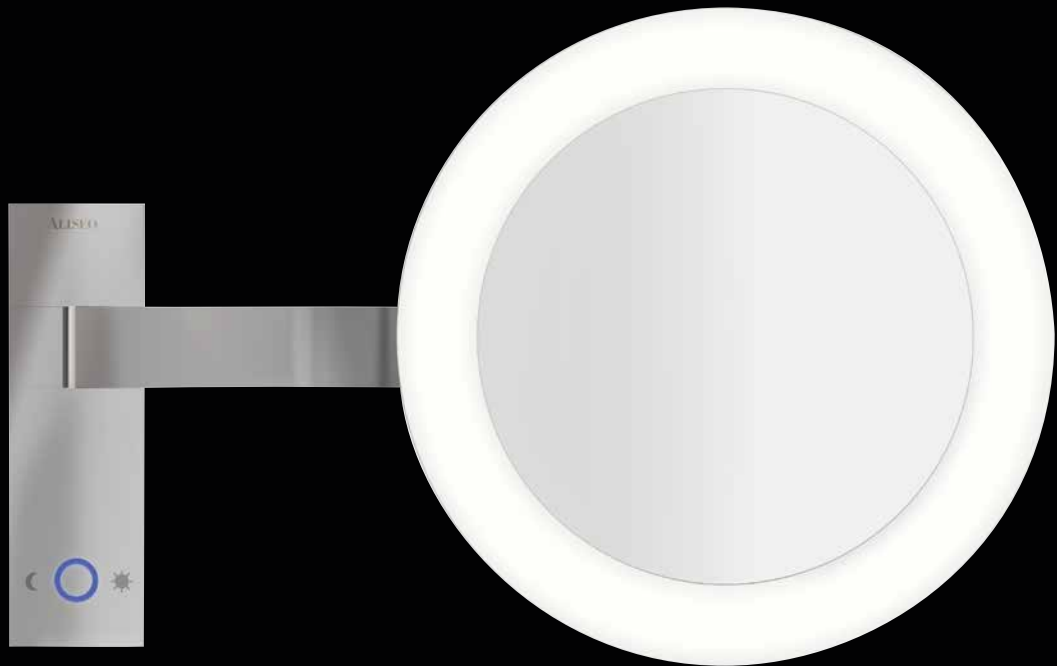

Tastschalter aktiviert wahlweise ein
warmweißes oder kühles weißes Licht /
Touch sensor offers the choice of a
warm white or cool white reflection



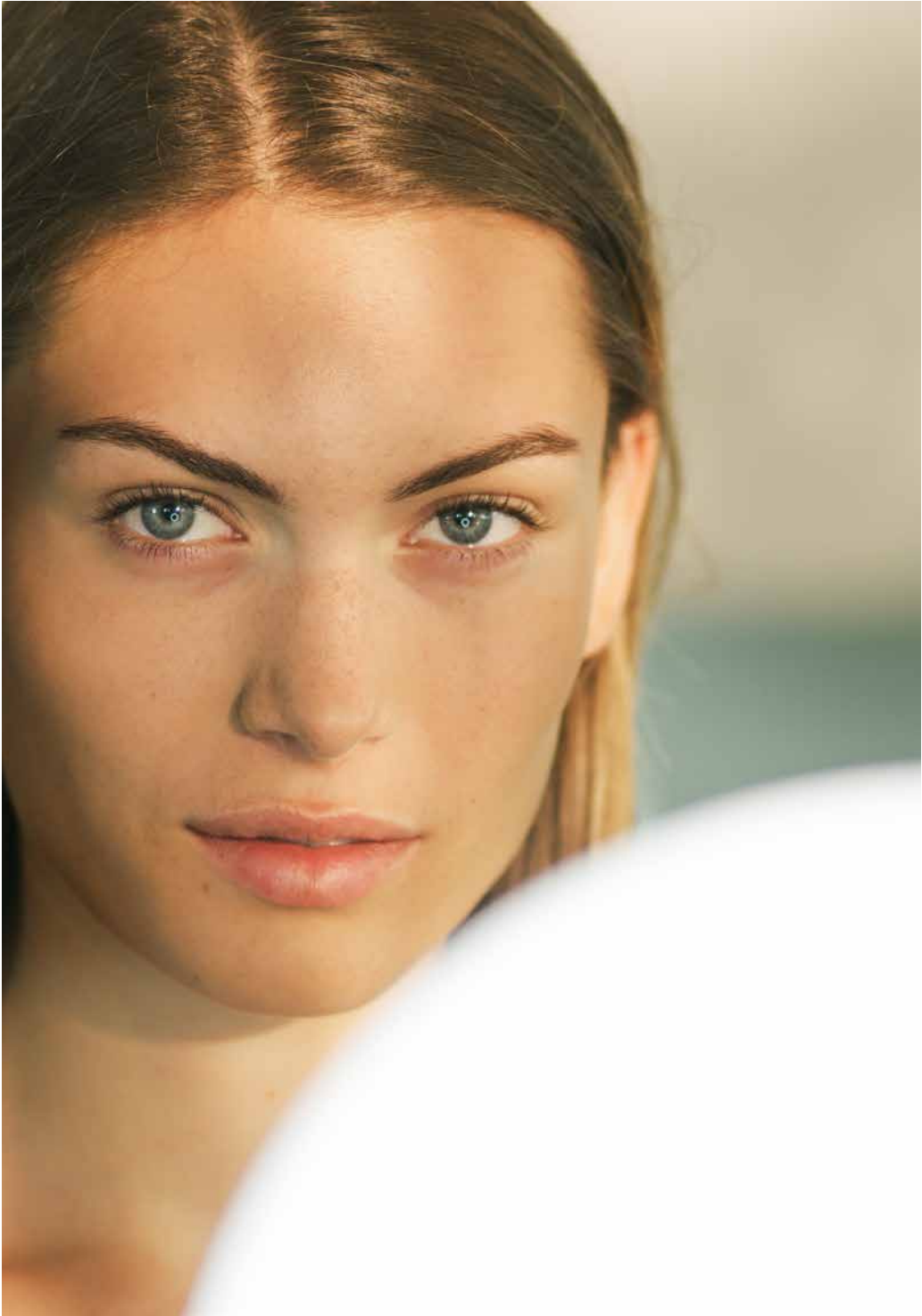

LED MOON DANCE

SMD-LED-Beleuchtung
 Warmweißes Licht, 3500-4000 K
 Kühles weißes Licht, 5000-5500 K
 3-fach-Vergrößerung
 High-Tech-Tastschalter
 Transluenter Acryl-Rahmen
 Kugelgelenk
 Schutzklasse I - Kontrollbox
 100-240 V
 Direktanschluss
 Messingkonstruktion

SMD-LED-lighting
 Warm white light, 3500-4000 K
 Cool white light, 5000-5500 K
 3x magnification
 Hi-tech touch control
 Translucent acrylic frame
 Full pivotal adjustment
 Class I - control box
 100-240 V
 Hard wire application
 Brass construction

IP44



Wandstange
 chrom, ø 240 mm /
 Wall bar
 chrome, ø 240 mm
020817

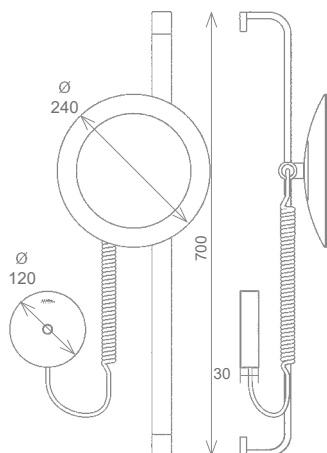

Transluenter Acryl-Rahmen /
 Translucent acrylic housing

T3 Kontrollbox /
 T3 Control Box



LED SATURN



Beleuchteter Tastschalter /
Illuminated touch sensor

Perfekte Ausleuchtung
bis zu 50.000 h wartungsfreie Beleuchtung /
LED pin-point reflection
up to 50,000 hour maintenance free illumination

"The Mirror Has Two Faces"



Green Efficiency



Two-Tone-Touch
Technology

Zwei unabhängige LED-Beleuchtungssysteme mit Tages- oder
Abendbeleuchtung /
Two independent LED systems with light reflective pigmentation



rotgold 209 / red gold 209

LED SATURN

SMD-LED-Beleuchtung
 Warmweißes Licht, 3500-4000 K
 Kühles weißes Licht, 5000-5500 K
 3-fach-Vergrößerung
 High-Tech-Tastschalter
 Kugelgelenk
 Schutzklasse I
 100-240 V
 Direktanschluss
 Messingkonstruktion

IP44



SMD-LED-lighting
 Warm white light, 3500-4000 K
 Cool white light, 5000-5500 K
 3x magnification
 Hi-tech touch control
 Full pivotal adjustment
 Class I
 100-240 V
 Hard wire application
 Brass construction

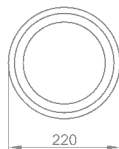

Am Schwenkarm
 chrom, ø 220 mm /
 On single arm
 chrome, ø 220 mm
020743

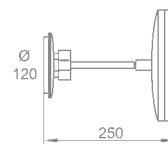

Am Doppel-Schwenkarm
 chrom, ø 220 mm /
 On Twin arm
 chrome, ø 220 mm
020744

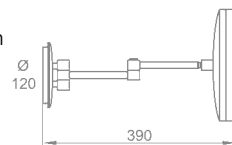

LED INTERFACE

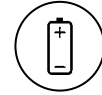

batteriebetrieben /
battery powered

Batteriebetrieben:

Schwenkarm:

4 x AA-Trockenbatterien oder

4 x AA-Akkubatterien

Standspiegel:

4 x 18650 Akkubatterien

Mit Anzeige bei schwacher Batterie

Leicht zugängliches Batterie-
fach mit Schnappschloss /

Battery powered:

Single arm:

4 x AA dry batteries or

rechargeable batteries

Free standing:

4 x 18650 rechargeable batteries

Complete with a low power indicator

Easily accessible snap-cover
battery compartment





INTERFACE

Automatisches Einschalten durch Gesichtsannäherung
 Ein Infrarot-Sensor aktiviert die automatische Ein-/Ausschaltung
 der LED-Beleuchtung im transluzenten Acrylrings
 im Abstand von 20 cm /

Lights automatically as your face approaches
 Auto ON/OFF infrared sensor activates a translucent
 acrylic edge LED lighting system.
 Operational up to 20 cm.



Sensor



batteriebetrieben /
 battery powered



automatische Ausschaltfunktion
 nach 15 Sek. / automatic switch
 -off after 15 sec.

LED INTERFACE



A MUCH APPRECIATED AFFORDABLE UPGRADE

INTERFACE zeichnet sich durch ein elegantes effizientes minimalistisches Design mit integrierter vertikaler Einstellung aus. Die transluzente Acryl-LED-Beleuchtung strahlt mit einem warmen, natürlichen, bernsteinfarbenen Schimmer. /

INTERFACE features an elegantly efficient minimalist design with an integrated vertical slot adjustment. Translucent acrylic LED lighting emits a warm natural amber glow.



NU finishes

Nickel gebürstet 307/
brushed nickel 307

Messing 206/
brass 206

chrom 100/
chrome 100

LED INTERFACE

SMD-LED-Beleuchtung
Warmweißes Licht, 3500-4000 K
3-fach-Vergrößerung
Verstärktes Dreh-/Kippgelenk
Batteriebetrieben
Messing-Komponenten

SMD-LED-lighting
Warm white light, 3500-4000 K
3x magnification
Sturdy reinforced pivot joint
Battery powered
Brass components

Standspiegel
chrom, ø 220 mm /
Freestanding
chrome, ø 220 mm
020849

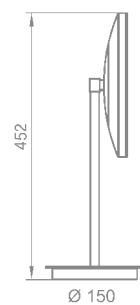

Am Schwenkarm
chrom, ø 220 mm
Adapterplatte für
bessere Stabilität /
On single arm
chrome, ø 220 mm
Adapter plate for
improved stability
020832

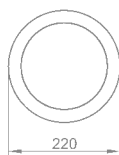
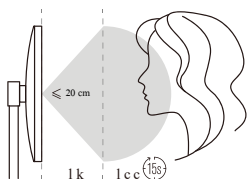
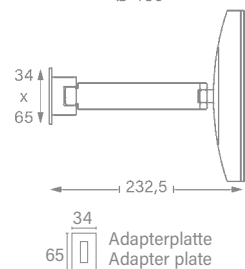





Stabiles Kugelgelenk für individuelle
Verstellbarkeit /
Reinforced ball joint for full pivotal
imaging

Perfekte Ausleuchtung
bis zu 50.000 h wartungsfreie Beleuchtung /
LED pin-point reflection
up to 50,000 hour maintenance free illumination





chrom gebürstet 302/
brushed chrome 302

LED CUBIK

SMD-LED-Beleuchtung
Warmweißes Licht, 3500-4000 K
Kühles weißes Licht, 5000-5500 K
3-fach-Vergrößerung
High-Tech-Tastschalter
Kugelgelenk
Schutzklasse I
100-240 V
Direktanschluss
Messingkonstruktion

IP44



SMD-LED-lighting
Warm white light, 3500-4000 K
Cool white light, 5000-5500 K
3x magnification
Hi-tech touch control
Full pivotal adjustment
Class I
100-240 V
Hard wire application
Brass construction

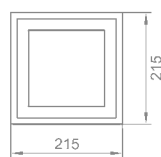

Am Schwenkarm
chrom, 215 x 215 mm /
On single arm
chrome, 215 x 215 mm

020745

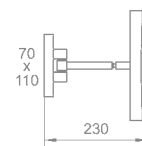

Am Doppel-Schwenkarm
chrom, 215 x 215 mm /
On twin arm
chrome, 215 x 215 mm

020746

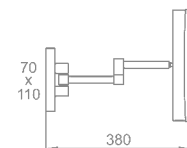

Standmodell
chrom, 215 x 215 mm /
Free standing
chrome, 215 x 215 mm

020747

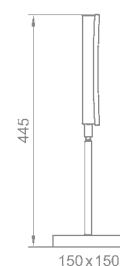

Wahlweise mit Tages- oder Abendbeleuchtung / Variable Day or Night time Illumination



Beleuchteter Tastschalter /
Illuminated two-position touch sensor



Wandhalterung mit integriertem
Tastschalter in schlanker Dreiecksform /
Low profile triangular wall bracket with
convenient integrated touch sensor



REFLECTION REDEFINED

Die puristische Schönheit dieses Spiegels entsteht durch die Harmonie seiner abgerundeten Kanten. Der transluzente Acrylring verstärkt die Lichtführung und prägt auf ganz besondere Weise das Gefühl von Anmut und zeitloser Eleganz. Die technische Raffinesse von Vision befindet sich in der selbstentwickelten SMD LED Beleuchtungsplatine, die leistungsstark und besonders energieeffizient ist. /

Gently curved profile framed by stunning edge-lit LED acrylics turns a room into a vibrant statement of personal taste. Aesthetic functionality at its finest; refined and durable twin-arm construction allows for a full range of motion and angular adjustments.

A re-imagination of a mirror reinvented.

Wartungsfreie Beleuchtung mit transluzentem Acyrlring
mit abgerundeten Kanten /
Gently curved profile framed by unique acrylic-edge
LED lighting provides full maintenance-free illumination

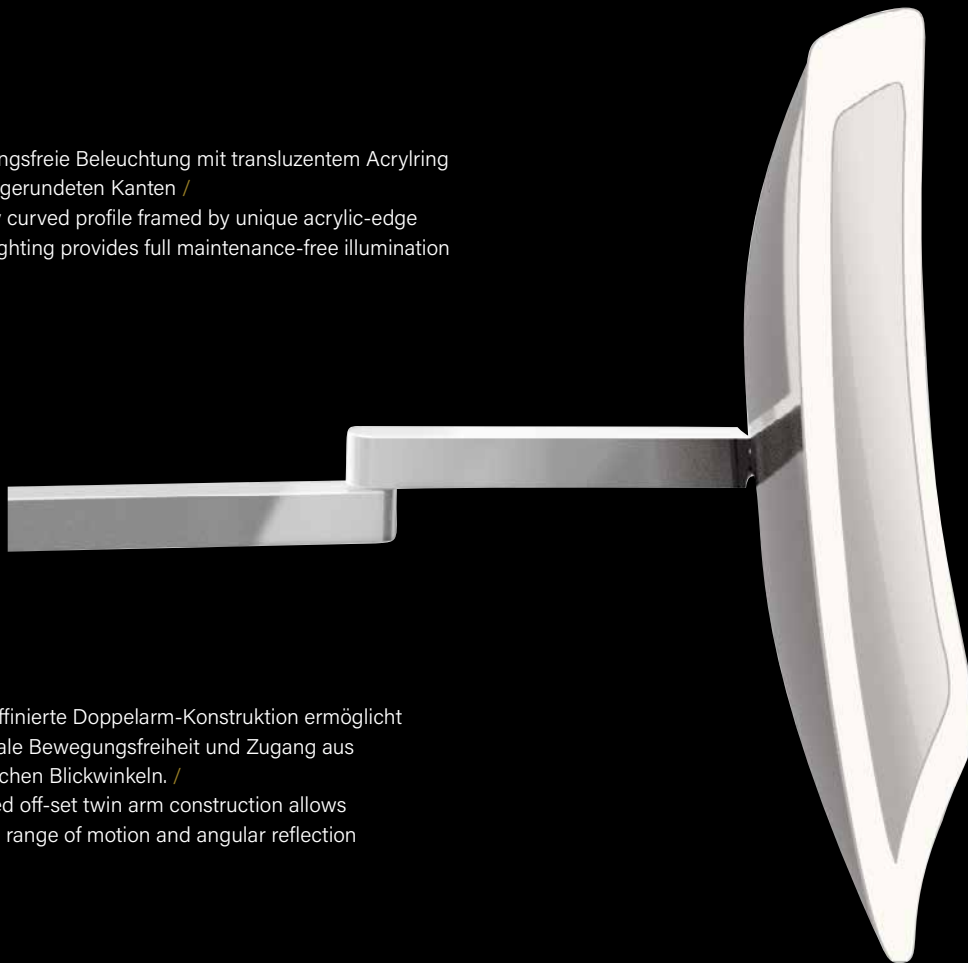

Die raffinierte Doppelarm-Konstruktion ermöglicht
optimale Bewegungsfreiheit und Zugang aus
sämtlichen Blickwinkeln. /
Refined off-set twin arm construction allows
for full range of motion and angular reflection



Green Efficiency

LED VISION

SMD-LED-Beleuchtung
Kühles weißes Licht, 5000-5500 K
3-fach-Vergrößerung
Kugelgelenk
High-Tech-Tastenschalter
Transluzenter Acryl-Rahmen
Schutzklasse I
120-240 V
Direktanschluss
Messing-Komponenten



SMD-LED-lighting
Cool white light, 5000-5500 K
3x magnification
Full pivotal adjustment
Hi-Tech touch control
Translucent acrylic frame
Class I
100-240 V
Hard wire application
Brass components

Am Doppel-Schwenkarm
chrom, 180 x 240 mm /
On Twin arm
chrome, 180 x 240 mm

020767

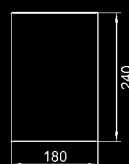
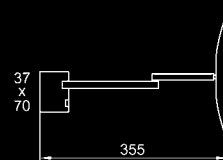



LED LUNATEC

SMD-LED-Beleuchtung
 Warmweißes Licht, 3500-4000 K
 3-fach-Vergrößerung
 Doppelwalzengelenk
 Schutzklasse I
 100-240 V
 Direktanschluss
 Messing-Komponenten
 ▶ 110 V auf Anfrage

SMD-LED-lighting
 Warm white light, 3500-4000 K
 3x magnification
 Full pivotal adjustment
 Class I
 100-240 V
 Hard wire application
 Brass components
 ▶ 110 V upon request

Am Schwenkarm
 chrom, ø 240 mm /
 On single arm
 chrome, ø 240 mm
020600

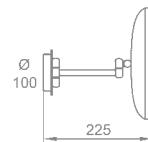

Am Doppel-Schwenkarm
 chrom, ø 240 mm /
 On twin arm
 chrome, ø 240 mm
020601

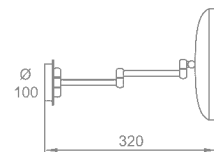

IP44

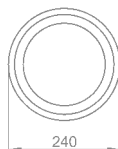



Green Efficiency



Perfekte Ausleuchtung
bis zu 50.000 h wartungsfreie
Beleuchtung /
LED pin-point reflection
up to 50,000 hour maintenance
free illumination

Space Saving - Multiflex Fold-Away Design



LED CITY LIGHT



Großzügiger 25 cm Durchmesser / Generous 25 cm diameter

Perfekte Ausleuchtung bis zu 50.000 h wartungsfreie Beleuchtung /
LED pin-point reflection up to 50,000 hour maintenance free illumination



Green Efficiency

LED CITY LIGHT

SMD-LED-Beleuchtung
Warmweißes Licht, 3500-4000 K
3-fach-Vergrößerung
Doppelwalzengelenk
Schutzklasse I
120-240 V
Direktanschluss

SMD-LED-lighting
Warm white light, 3500-4000 K
3x magnification
Full pivotal adjustment
Class I
120-240 V
Hard wire application



Am Doppel-Schwenkarm
chrom, ø 250 mm /
On twin arm
chrome, ø 250 mm

020657

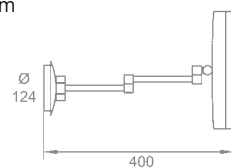

Am Doppel-Schwenkarm
schwarz matt, ø 250 mm /
On twin arm
black matt, ø 250 mm

020801

Am Schwenkarm
chrom, ø 250 mm /
On single arm
chrome, ø 250 mm

020677

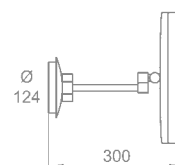



schwarz matt / black matt

NU finishes





LED ME

Acryl-Hintergrundbeleuchtung
 SMD-LED-Beleuchtung
 Warmweißes Licht, 3500-4000 K
 3-fach-Vergrößerung
 Doppelwalzengelenk
 Schutzklasse I
 100-240 V
 Direktanschluss

Acrylic - back light design
 SMD-LED-lighting
 Warm white light, 3500-4000 K
 3x magnification
 Multiple vertical, pivotal and
 swing arm adjustment
 Class I
 100-250 V
 Hard wire application



Am Schwenkarm
 chrom, ø 220 mm /
 On single arm
 chrome, ø 220 mm
020835

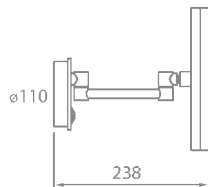

Am Doppel-Schwenkarm /
 chrom, ø 220 mm
 On twin arm
 chrome, ø 220 mm
020836

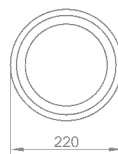
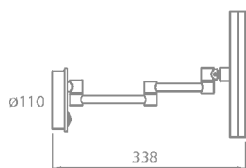

Green Efficiency

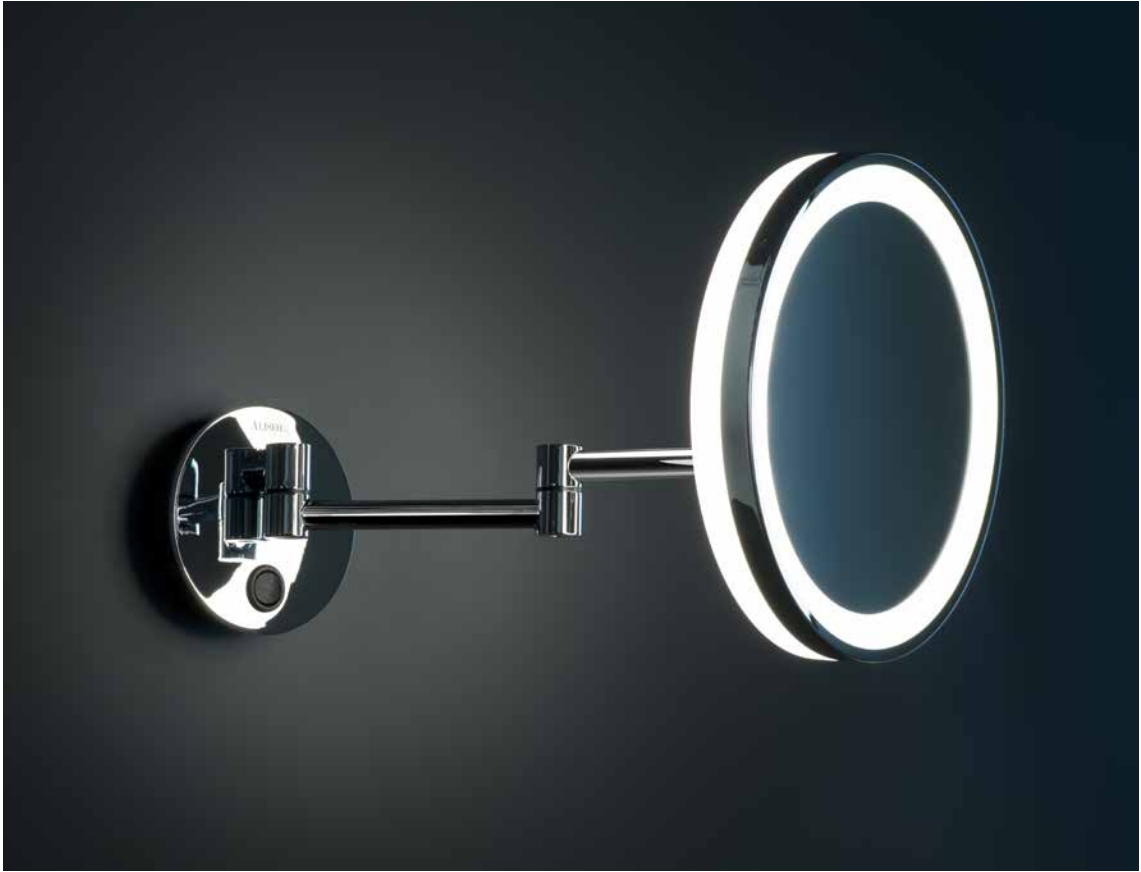

Mit Acryl-Hintergrundbeleuchtung / With acrylic-back light design

LED MY

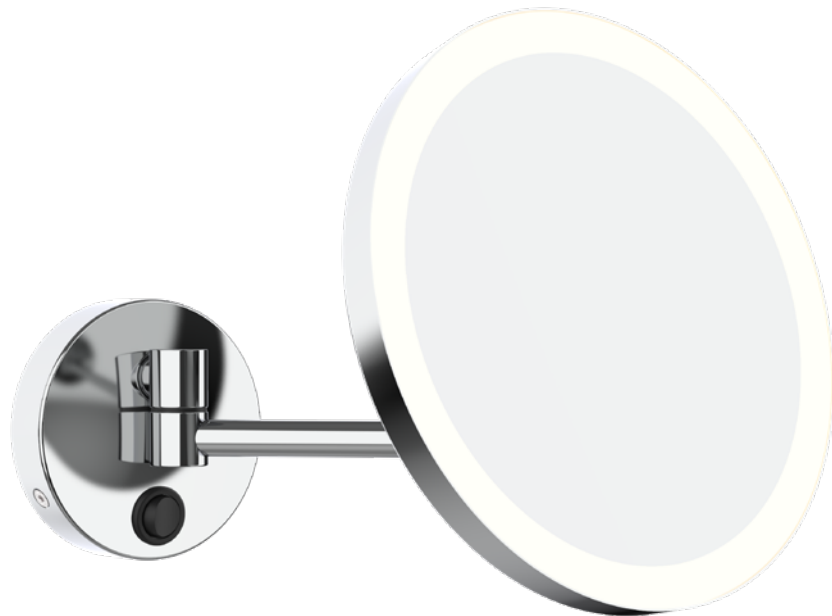

LED MY

SMD-LED-Beleuchtung
Warmweißes Licht, 3500-4000 K
3-fach-Vergrößerung
Doppelwalzengelenk
Schutzklasse I
100-240 V
Direktanschluss

SMD-LED-lighting
Warm white light, 3500-4000 K
3x magnification
Multiple vertical, pivotal and
swing arm adjustment
Class I
100-250 V
Hard wire application



Am Schwenkarm
chrom, ø 220 mm /
On single arm
chrome, ø 220 mm

020843

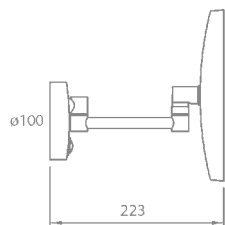

Am Doppel-Schwenkarm
chrom, ø 220 mm /
On twin arm
chrome, ø 220 mm

020844

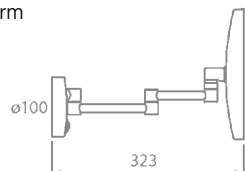



Maximale Einstellmöglichkeiten in einem vollverchromten Gehäuse. /
Maximum adjustability in a full chrome housing.



Green Efficiency



COSMO MINIMALIST



Feinjustierbar /
Fingertip adjustment

COSMO MINIMALIST

3-fach-Vergrößerung
Kugelgelenk

3x magnification
Full pivotal adjustment

Standmodell
chrom, ø 200 mm /
Free standing
chrome, ø 200 mm

020488

Standmodell
schwarz matt, ø 200 mm /
Free standing
black matt, ø 200 mm

020805



schwarz matt /
black matt

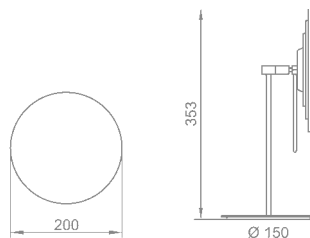



COSMO MINIMALIST

3-fach-Vergrößerung
Kippgelenk
Verdeckte Montageeinheit
Messing-Komponenten

3x magnification
Full pivotal adjustment
Covered backplate
Brass components

Am Schwenkarm
chrom, ø 200 mm /
On single arm
chrome, ø 200 mm
020607

Am Schwenkarm
schwarz matt
ø 200 mm /
On single arm
black matt
ø 200 mm
020804

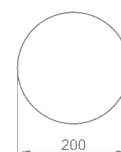
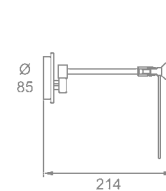



NU finishes

goldoptik 203/
gold optic 203



Ultra-schlankes, platzsparendes Design. Flach an die Wand klappbar. /
Ultra slim space saving design. Folds flat to the wall.

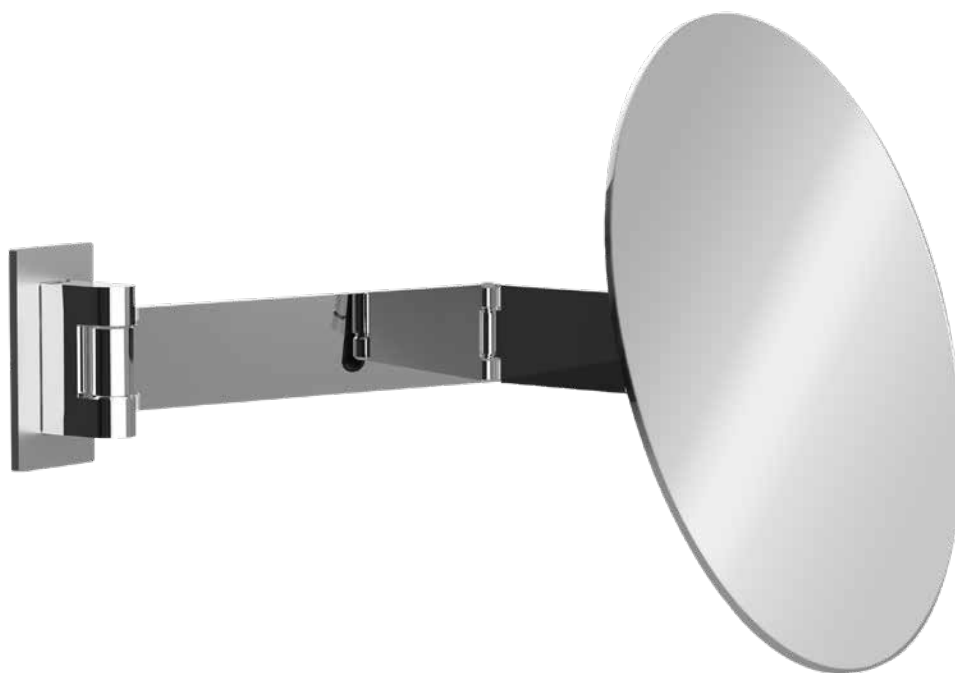

FACE

3-fach-Vergrößerung
Dreh-/ Kippgelenk
Verdeckte Montageeinheit

3x magnification
Full pivotal adjustment
Covered backplate

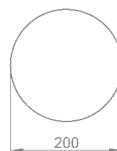

Am Schwenkarm
chrom, \varnothing 200 mm
Adapterplatte für
bessere Stabilität /
On single arm
chrome, \varnothing 200 mm
Adapter plate for
improved stability

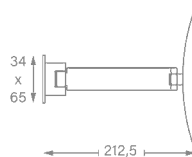

34
65
Adapterplatte
Adapter plate

020831

Am Doppel-Schwenkarm
chrom, \varnothing 200 mm
Adapterplatte für
bessere Stabilität /
On twin arm
chrome, \varnothing 200 mm
Adapter plate for
improved stability

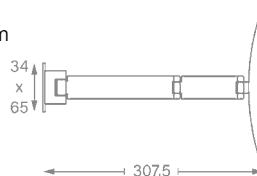

34
65
Adapterplatte
Adapter plate

020829



Höhenverstellbar. Flach an die Wand klappbar. / Height adjustable. Folds flat to the wall.

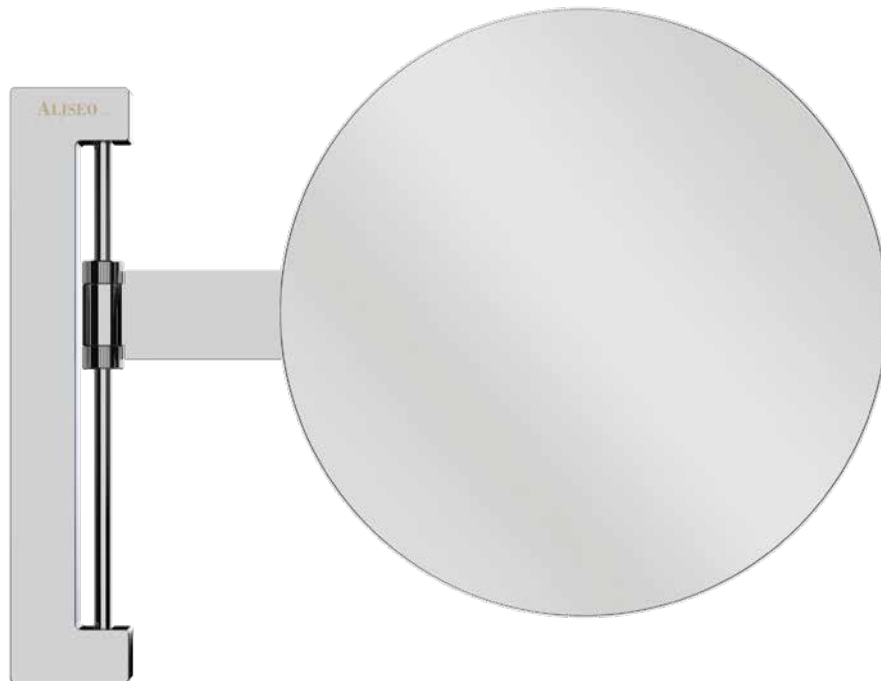

FACE plus

3-fach-Vergrößerung
 Höhenverstellbar mit
 Schwenkeinstellungen
 Schwenkarm an die Wand klappbar
 Verdeckte Montageeinheit
 Verdeckte Schrauben

3x magnification
 Height adjustable with
 pivotal adjustments
 Swivel arm folds to the wall
 Covered mounting bracket
 Concealed screws

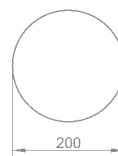

Am Schwenkarm
 Montage rechts
 chrom, ø 200 mm /
 On single arm
 right mounting
 chrome, ø 200 mm

020834

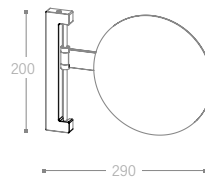

Am Schwenkarm
 Montage links
 chrom, ø 200 mm /
 On single arm
 left mounting
 chrome, ø 200 mm

020837

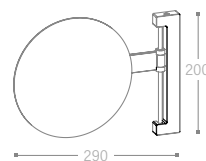



Höhenverstellbare Gleiter /
Sure-grip lock-in system



An Wandstange (kürzbar)
3-fach-Vergrößerung
Spiegel: ABS-Kunststoff /
On wall bar (shortenable)
3x magnification
Mirror: ABS-plastic

chrom, ø 190 mm /
chrome, ø 190 mm

020011

chrom, ø 220 mm /
chrome, ø 220 mm

020012

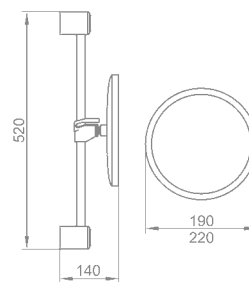

Höhenverstellbar /
Height adjustable



Plan- und 3-fach-Vergrößerung
Höhenverstellbar
Verdeckte Montageeinheit
Messing-Komponenten
Am Schwenkarm
chrom, ø 200 mm /
Plain and 3x magnification
Height adjustable
Covered backplate
Brass components
On single arm
chrome, ø 200 mm

020597

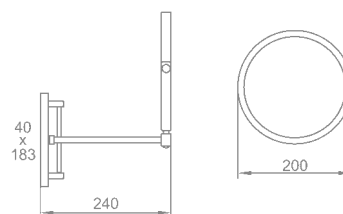

Plan- und 3-fach-Vergrößerung
 Verdeckte Montageeinheit
 Messing-Komponenten
 Am Schwenkarm
 chrom, ø 200 mm /
 Plain and 3x magnification
 Covered backplate
 Brass components
 On single arm
 chrome, ø 200 mm
020506

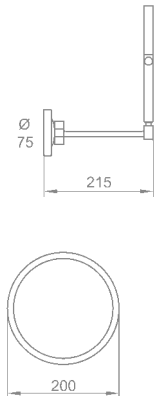

SICHERE BEFESTIGUNG
 Separate Montageeinheit
 Maximale Stabilität
 Perfekt in Funktion und Design /
 SECURE MOUNTING
 Separate mounting bracket
 Maximum stability
 A finished elegant appearance

Am Doppel-Schwenkarm
 schwarz matt, ø 200 mm /
 On twin arm
 black matt, ø 200 mm
020802

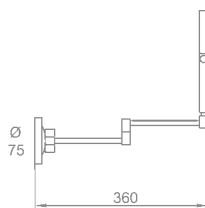

schwarz matt /
 black matt



Modellübersicht / Product Overview

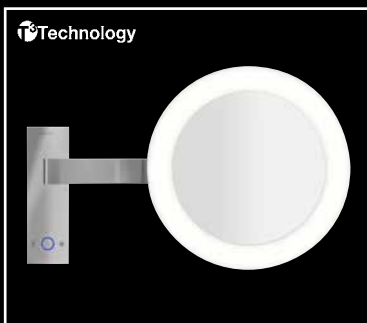

020758 LED MOON DANCE
 ø 240 mm. Ausgestreckt 320 mm
 ø 240 mm. Extends to 320 mm



020759 LED MOON DANCE
 ø 240 mm. Höhe 420 mm
 ø 240 mm. Height 420 mm



020817 LED MOON DANCE
 ø 240 mm. Höhe 700 mm
 ø 240 mm. Height 700 mm



020743 LED SATURN
 ø 220 mm. Ausgestreckt 250 mm
 ø 220 mm. Extends to 250 mm



020744 LED SATURN
 ø 220 mm. Ausgestreckt 390 mm
 ø 220 mm. Extends to 390 mm

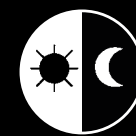

Technology
 Two-Tone-Touch

Two Tone Touch Control ist ein innovatives zweistufiges Beleuchtungssystem. Der Gast kann über einen einfach zu bedienenden Tastschalter selbst entscheiden, ob er lieber ein helles Tageslicht oder warmes Abendlicht bevorzugt. / Two-Tone-Touch lighting bathes the skin in a shadow-free soft white or warm light for the most exacting cosmetic applications. Illuminated touch sensor offers the user their choice of a cool white daytime look or a warmer night-time reflection.



020832 LED INTERFACE
 ø 220 mm. Ausgestreckt 232,5 mm
 ø 220 mm. Extends to 232,5 mm



020849 LED INTERFACE
 ø 220 mm. Höhe 452 mm
 ø 220 mm. Height 452 mm



020745 LED CUBIK
 215 x 215 mm. Ausgestreckt 230 mm
 215 x 215 mm. Extends to 230 mm



020746 LED CUBIK
 215 x 215 mm. Ausgestreckt 380 mm
 215 x 215 mm. Extends to 380 mm



020747 LED CUBIK
 215 x 215 mm. Höhe 445 mm
 215 x 215 mm. Height 445 mm



Modellübersicht / Product Overview



020767 LED VISION
180 x 240 mm. Ausgestreckt 355 mm
180 x 240 mm. Extends to 355 mm



020600 LED LUNATEC
ø 240 mm. Ausgestreckt 225 mm
ø 240 mm. Extends to 225 mm



020601 LED LUNATEC
ø 240 mm. Ausgestreckt 320 mm
ø 240 mm. Extends to 320 mm

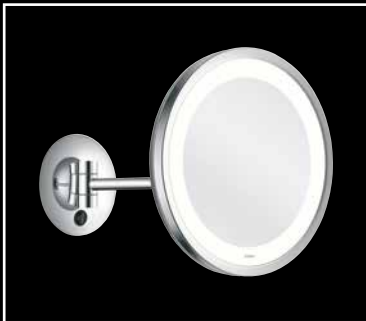

020677 LED CITY LIGHT
ø 250 mm. Ausgestreckt 300 mm
ø 250 mm. Extends to 300 mm

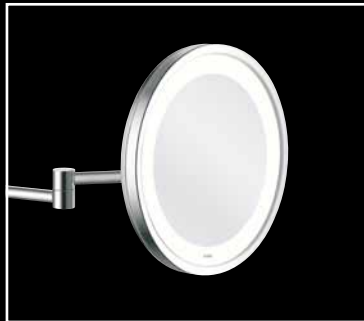

020657 LED CITY LIGHT
ø 250 mm. Ausgestreckt 400 mm
ø 250 mm. Extends to 400 mm



020801 LED CITY LIGHT
ø 250 mm. Ausgestreckt 400 mm
ø 250 mm. Extends to 400 mm

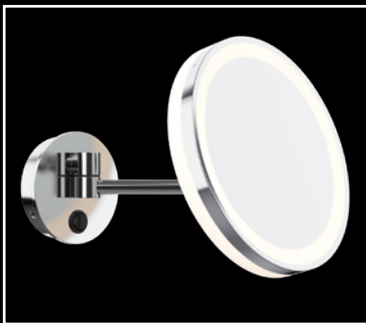

020835 LED ME
ø 220 mm. Ausgestreckt 238 mm
ø 220 mm. Extends to 238 mm

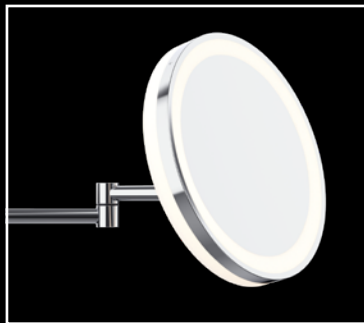

020836 LED ME
ø 220 mm. Ausgestreckt 338 mm
ø 220 mm. Extends to 338 mm

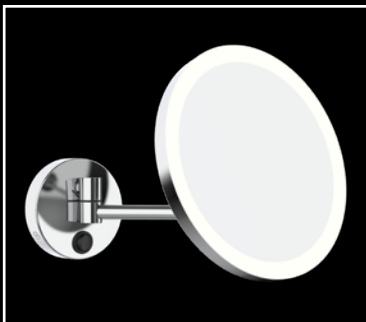

020843 LED MY
ø 220 mm. Ausgestreckt 223 mm
ø 220 mm. Extends to 223 mm

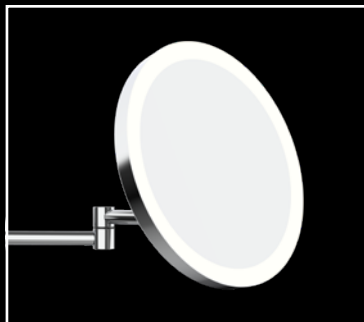

020844 LED MY
ø 220 mm. Ausgestreckt 323 mm
ø 220 mm. Extends to 323 mm



NU finishes

Alle Spiegel in verchromter Oberfläche.
Erhältlich in weiteren Ausführungen. /
All mirrors in chrome finish.
Available in additional finishes.



Modellübersicht / Product Overview

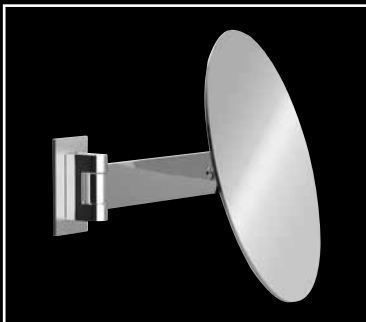

020831 FACE
ø 200 mm. Ausgestreckt 212,5 mm
ø 200 mm. Extends to 212,5 mm

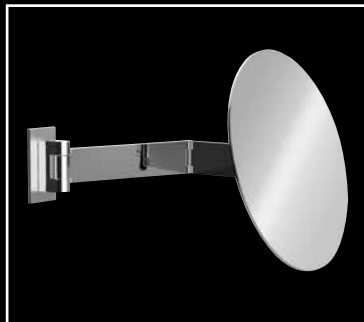

020829 FACE
ø 200 mm. Ausgestreckt 307,5 mm
ø 200 mm. Extends to 307,5 mm

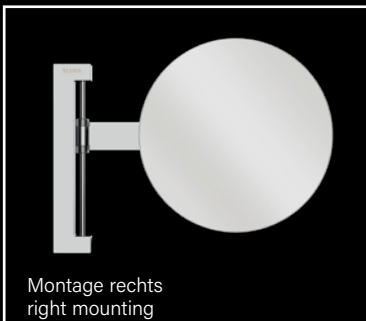

020834 FACE plus
ø 200 mm. Ausgestreckt 290 mm
ø 200 mm. Extends to 290 mm

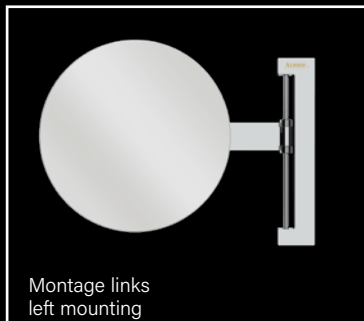

020837 FACE plus
ø 200 mm. Ausgestreckt 290 mm
ø 200 mm. Extends to 290mm

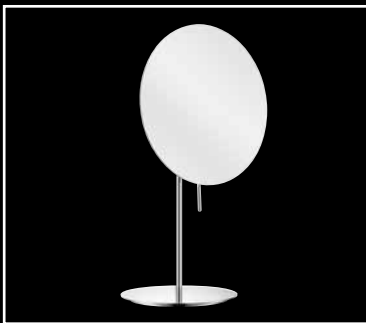

020488 COSMO MINIMALIST
ø 200 mm. Höhe 353 mm
ø 200 mm. Height 353 mm



020805 COSMO MINIMALIST
ø 200 mm. Höhe 353 mm
ø 200 mm. Height 353 mm

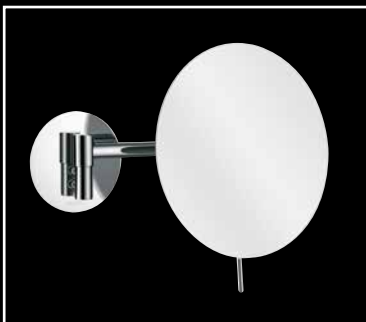

020607 COSMO MINIMALIST
ø 200 mm. Ausgestreckt 214 mm
ø 200 mm. Extends to 214 mm

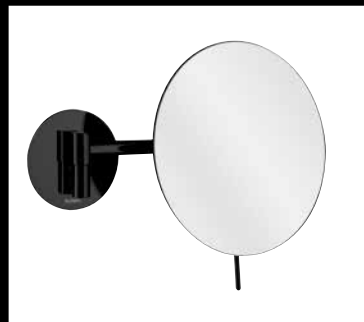

020804 COSMO MINIMALIST
ø 200 mm. Ausgestreckt 214 mm
ø 200 mm. Extends to 214 mm



Modellübersicht / Product Overview



020597 CONCIERGE
ø 200 mm. Ausgestreckt 240 mm
ø 200 mm. Extends to 240 mm



020506 CONCIERGE
ø 200 mm. Ausgestreckt 215 mm
ø 200 mm. Extends to 215 mm



020802 CONCIERGE
ø 200 mm. Ausgestreckt 360 mm
ø 200 mm. Extends to 360 mm

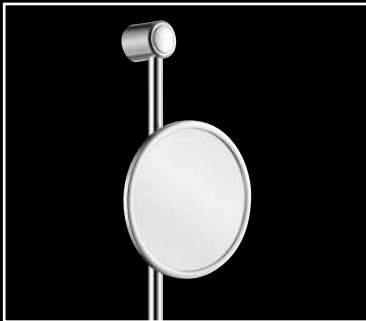

020011 CONCIERGE
ø 190 mm. Höhe 520 mm
ø 190 mm. Height 520 mm

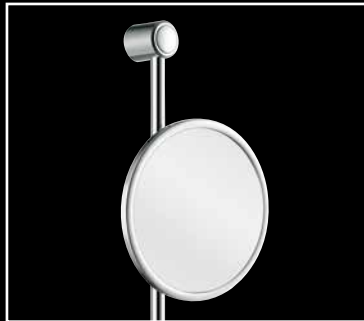

020012 CONCIERGE
ø 220 mm. Höhe 520 mm
ø 220 mm. Height 520 mm



NU finishes

Alle Spiegel in verchromter Oberfläche.
Erhältlich in weiteren Ausführungen. /
All mirrors in chrome finish.
Available in additional finishes.

BADEZIMMER ACCESSOIRES BATHROOM ACCESSORIES

DIFFERENT BATHROOMS. DIFFERENT LOOKS

Aliseos Badezimmer-Accessoires lassen sich individuell auf Ihre Badplanung abstimmen: die moderne NOW, die kraftvolle ARCHITECTO, die zeitlose TECNO, einzigartige NEXXUS und die kompromisslose MAXIMA ✓

Aliseo's accessories offer a visual stability and luxurious balance that complement the many different looks in bathroom décor: the contemporary NOW, the more defined ARCHITECTO, the timeless TECNO, the unique NEXXUS and the uncompromising MAXIMA.



Mit den NU finishes gestalten Sie alle Kosmetikspiegel und Badaccessoires in Ihrer Wunschoberfläche und -farbe. Wir setzen diese dann als hochwertige PVD-Beschichtung um. Brillant, langlebig, kratz- und korrosionsbeständig und einfach zu reinigen. ✓

With NU finishes, you can customize all cosmetic mirrors and bathroom accessories in the surface and color of your choice. We then apply these as a high-quality PVD coating. Brilliant, durable, scratch and corrosion-resistant and easy to clean.

Alle ALISEO Hotelbad-Accessoires werden aus Messing hergestellt und kommen mit einer verchromten Oberfläche. Allerbeste Qualität also. Werden andere Materialien verwendet weisen wir sie darauf hin.

Auf unsere verchromten Oberflächen gewähren wir eine freiwillige Garantie von 10 Jahren. Die beiden Serien mit Pulverbeschichtung NEXXUS und MAXIMA haben eine Garantie von 2 Jahren. Bitte beachten Sie unsere Montage- und Pflegehinweise. ✓

All ALISEO hotel bathroom accessories are made of brass and come with a chrome-plated surface. The very best quality. If other materials are used, we will point this out to you.

We grant a voluntary guarantee of 10 years on our chrome-plated surfaces. Please follow our installation and maintenance guidelines.





ARCHITECTO



TECNO



NOW



NEXXUS



MAXIMA



COMPLIMENTARY



HOCKER
STOOLS



HYGIENEEIMER
WASTE BINS



WAAGEN
SCALES

A R C H I T E C T O





770018
Sicherheits-Haltegriff /
Safety Grab Bar

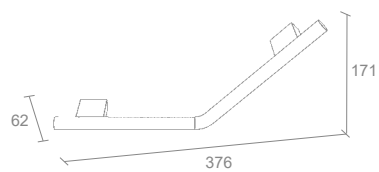



770005
Haken /
Hook

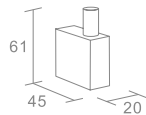

770011
Seifenhalter
Keramikschale /
Soap Dish
Ceramic Dish

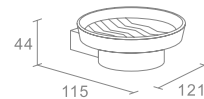

770012
Seifenspender
Keramik /
Soap Dispenser
Ceramic

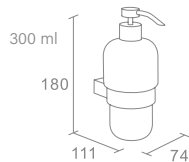

770009
Becherhalter
Keramikbecher /
Tumbler Holder
Ceramic Tumbler

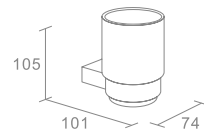

770016
Handtuchhalter /
Towel Rail

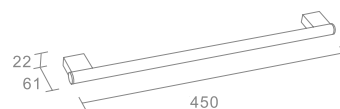



770006
 Papierrollenhalter /
 Toilet Roll Holder

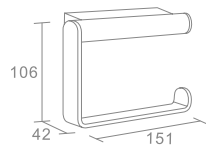

770007
 Reserverollenhalter /
 Spare Roll Holder

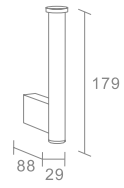

770017
 Papierrollenhalter /
 Toilet Roll Holder

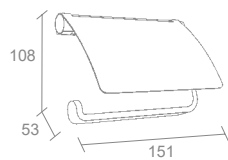

770008
 WC-Bürstengarnitur
 Keramikbehälter /
 Toilet Brush Holder
 Ceramic Case

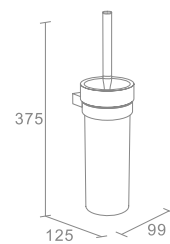



T E C N O



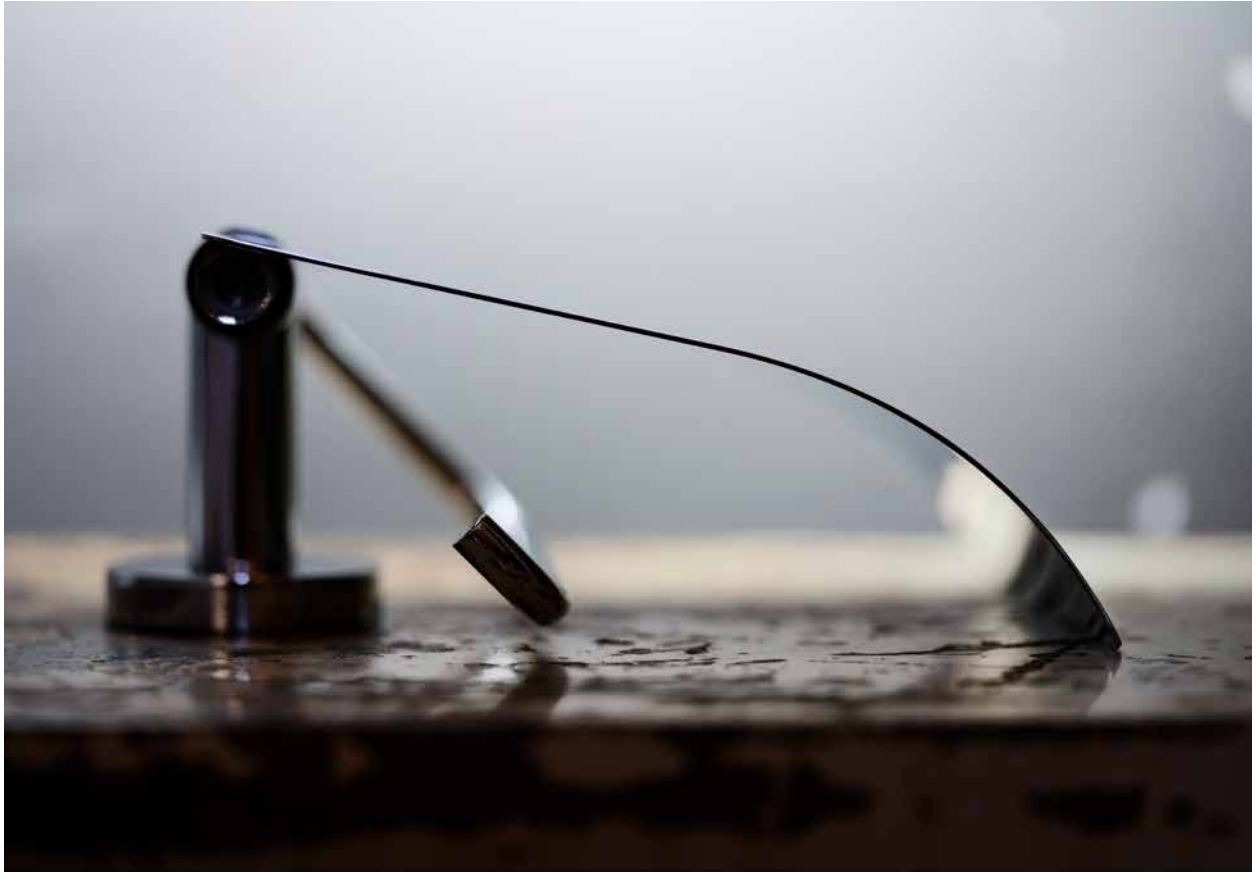

710013
Papierrollenhalter /
Toilet Roll Holder

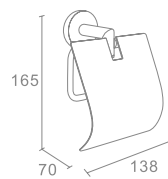



710008
 Papierrollenhalter /
 Toilet Roll Holder

710061
 Ausführung links /
 Left hand mount

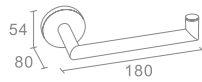

710009
 Reserverollenhalter /
 Spare Roll Holder

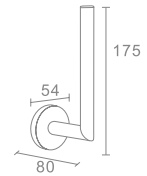

710014
 Doppel-Haken /
 Double Hook

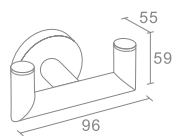

710006
 Haken /
 Hook

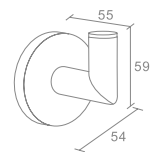

WC-Bürstengarnitur /
Toilet Brush Holder

030633
Standmodell /
freestanding

030707
Wandmontage /
Wall mounted

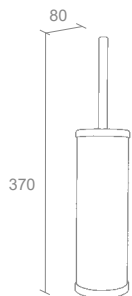



710010
 WC-Bürstengarnitur
 Satiniertes Glas /
 Toilet Brush Holder
 Iced Glass

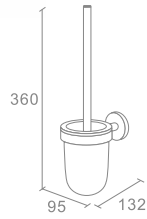



Sicherheits-Haltegriff /
Safety Grab Bar

710053/ 710054

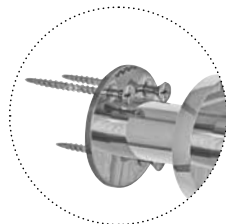
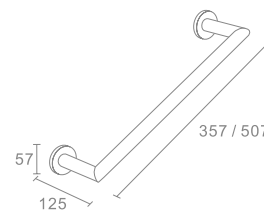

**FORMVOLLENDETE STÄRKE,
SICHERHEIT UND STABILITÄT**

3-Punkt-Befestigung

Zugbelastung bis zu 190 kg

je nach Wandbauart /

**STYLISH STRENGTH, SAFETY
AND STABILITY**

Positive 3 point fixation system

Up to 190 kilo pull-weight capacity

depending on wall construction



710056

Sicherheits-Haltegriff mit Seifenkörbchen

Wechselseitige Montage /

Safety Grab Bar with Soap Basket

Adjusts to left and right hand installations

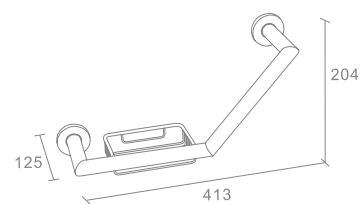



710059
Handtuchablage /
Towel Rack

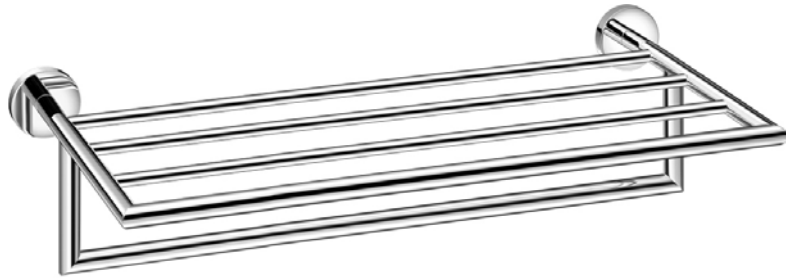
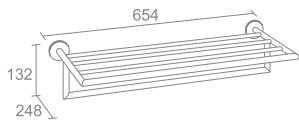

Handtuchhalter /
Towel Rail

710003/ 710052

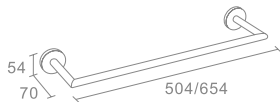

N O W





740006
 Papierrollenhalter /
 Toilet Roll Holder

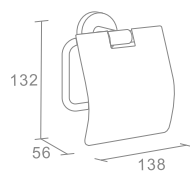

740007
 Papierrollenhalter /
 Toilet Roll Holder

740066
 Ausführung links /
 Left hand mount

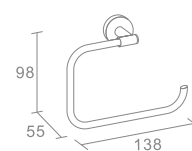



740017
Reserverollenhalter /
Spare Roll Holder



740008
Papierrollenhalter /
Toilet Roll Holder

740065
Ausführung links /
Left hand mount

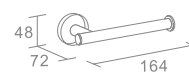

740009
WC-Bürstengarnitur
Satinieretes Glas /
Toilet Brush Holder
Iced Glass

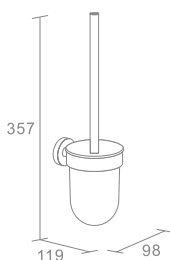

740018
WC-Bürstengarnitur. Standmodell
Edelstahl verchromt /
Toilet Brush Holder. Free standing
Stainless steel, chrome finish

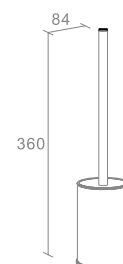



740004
Doppel-Haken /
Double Hook

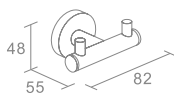

740016
Haken /
Hook

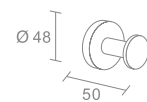



740010
 Glashalter
 Satiniertes Glas /
 Glass Holder
 Iced Glass

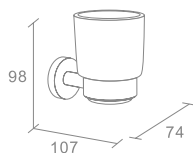

030615
 Seifenspender MOON
 Satiniertes Glas /
 Soap Dispenser MOON
 Iced Glass

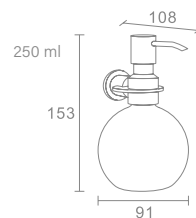

**Nicht für die Dusche geeignet /
 Not suitable for use in the shower

740001
 Handtuchablage /
 Towel Rack



Handtuchhalter /
 Towel Rail

740002



740013



N E X X U S







740050

Haken /
Hook

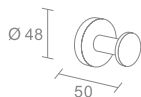

740045

Doppel-Haken /
Double Hook

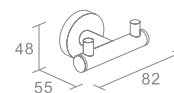

740053

Seifenhalter
Satinieretes Glas /
Soap Dish
Iced Glass

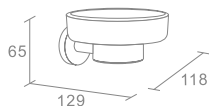

740052

Glashalter
Satinieretes Glas /
Glass Holder
Iced Glass

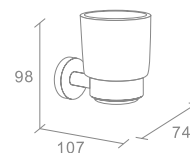

740047/ 740054

Handtuchhalter /
Towel Rail





740038
 Papierrollenhalter /
 Toilet Roll Holder

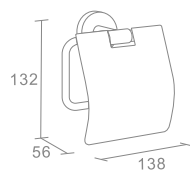

740042
 Papierrollenhalter /
 Toilet Roll Holder

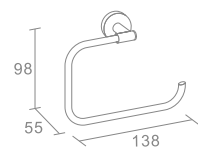

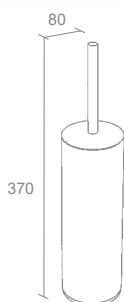

030708
WC-Bürstengarnitur
Wandmontage /
Toilet Brush Holder
Wall Mounted

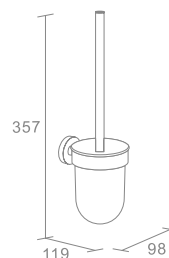

740044
WC-Bürstengarnitur
Satinieretes Glas /
Toilet Brush Holder
Iced Glass



740046
Reserverollenhalter /
Spare Roll Holder

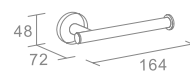

740043
Papierrollenhalter /
Toilet Roll Holder

M A X I M A





Material: Zamak mit Pulverbeschichtung / Material: Zamak with powder coating

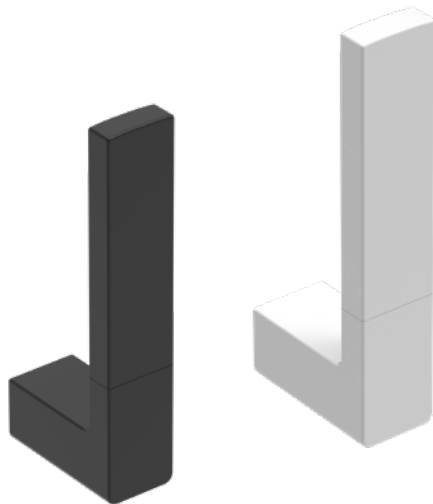

793004 - schwarz matt / black matt
794004 - weiß matt / white matt

Reserverollenhalter /
Spare Roll Holder

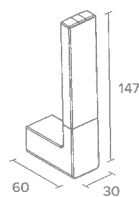

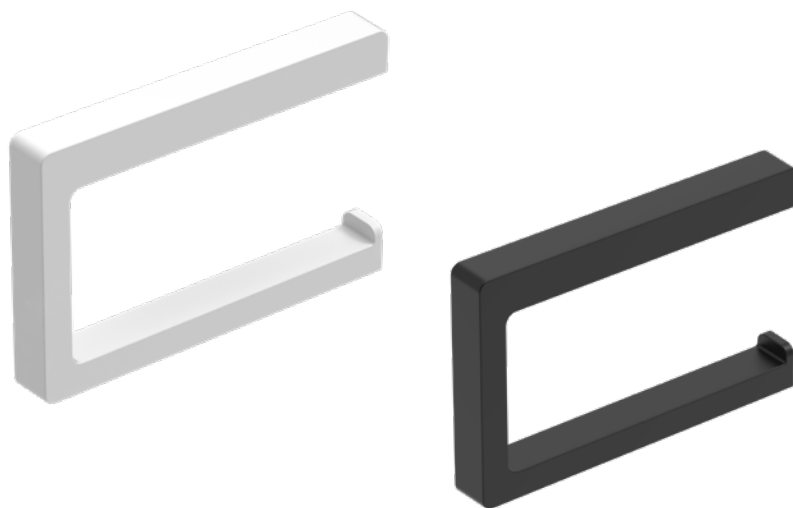

793003 - schwarz matt / black matt

794003 - weiß matt / white matt

Papierrollenhalter /
Toilet Roll Holder

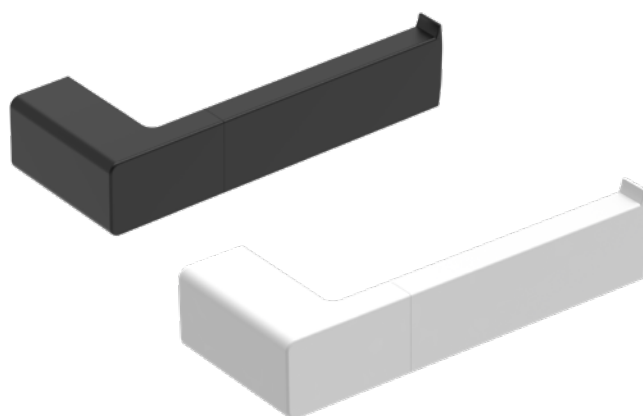
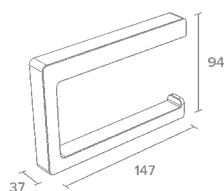

793002 -- schwarz matt / black matt

794002 - weiß matt / white matt

Papierrollenhalter /
Toilet Roll Holder

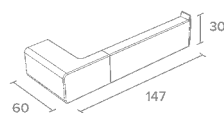

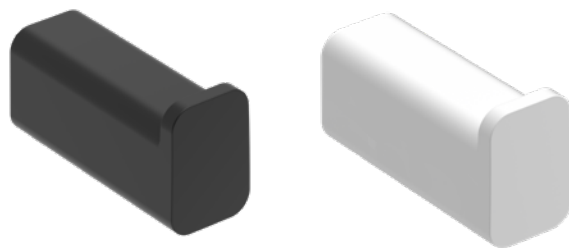

793001 - schwarz matt / black matt
794001 - weiß matt / white matt

Haken /
Hook

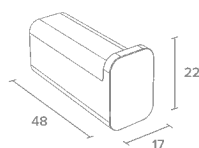

030672 - schwarz matt / black matt
030674 - weiß matt / white matt

WC-Bürstengarnitur
Wandmontage oder Standmodell
Herausnehmbarer Kunststoffeinsatz /
Toilet Brush Holder
Wall mounted or free standing model
Removable plastic insert

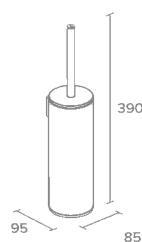

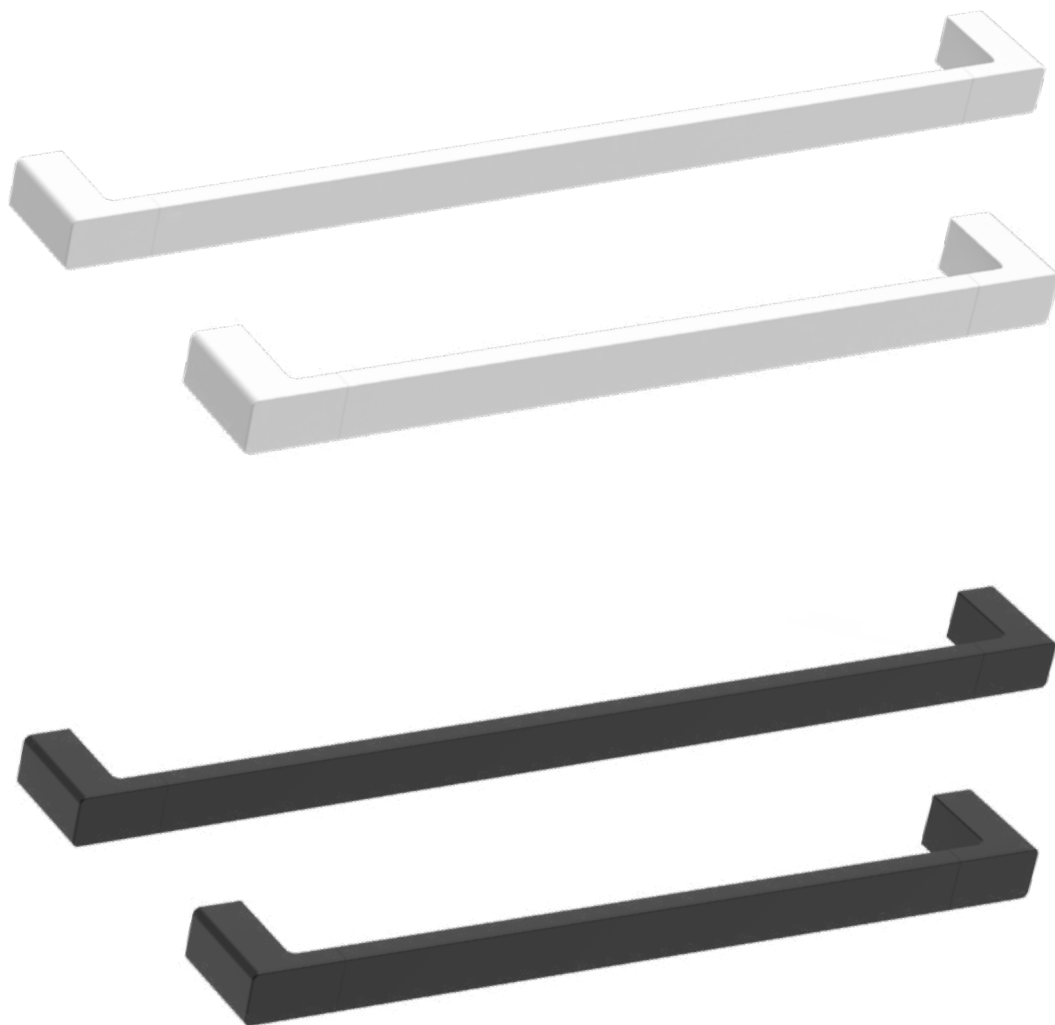

793005 - schwarz matt / black matt
794005 - weiß matt / white matt

Handtuchhalter /
 Towel Rail

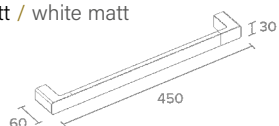

793006 - schwarz matt / black matt
794006 - weiß matt / white matt

Handtuchhalter /
 Towel Rail

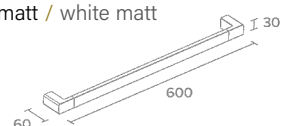



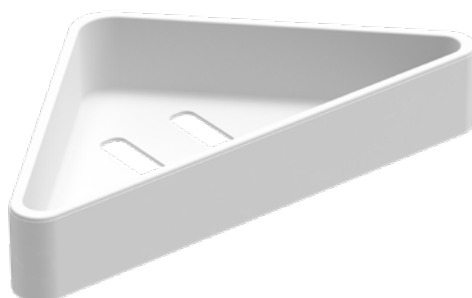
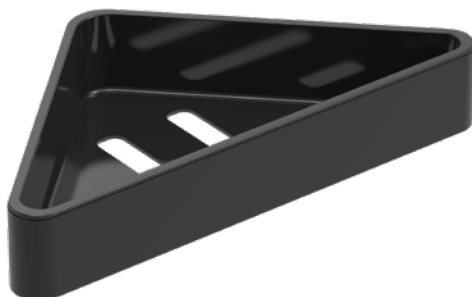

033677 - schwarz / black
034677 - weiß / white

Seifenkörbchen
Edelstahl mit matter
Pulverbeschichtung
Herausnehmbarer ABS-
Kunststoffeinsatz /
Corner Soap basket
Stainless steel with
matt powder coating
Removable, ABS plastic insert

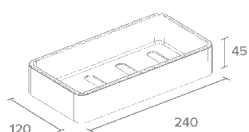

033671 - schwarz / black
034671 - weiß / white

Eckseifenkörbchen
Edelstahl mit matter
Pulverbeschichtung
Herausnehmbarer ABS-
Kunststoffeinsatz /
Corner Soap basket
Stainless steel with
matt powder coating
Removable, ABS plastic insert

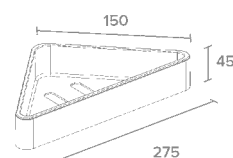

ARCHITECTO

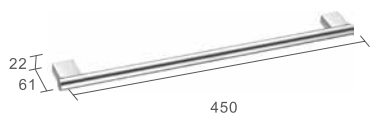

770016



770018

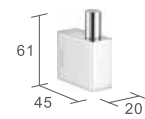

770005

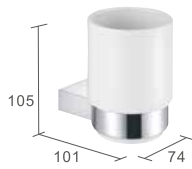

770009



770012

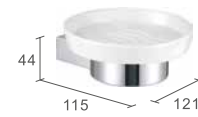

770011

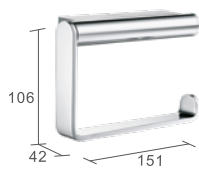

770006

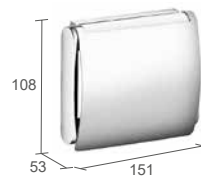

770017

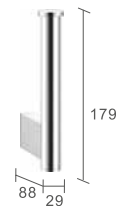

770007



770008

MAXIMA

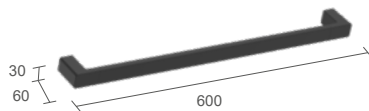

793006 - schwarz / black matt
794006 - weiß / white matt



793005 - schwarz / black matt
794005 - weiß / white matt

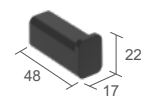

793001 - schwarz / black matt
794001 - weiß / white matt

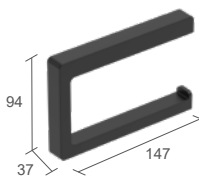

793003 - schwarz / black matt
794003 - weiß / white matt

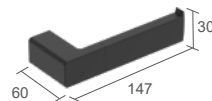

793002 - schwarz / black matt
794002 - weiß / white matt

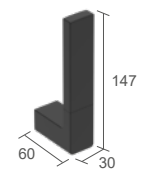

793004 - schwarz / black matt
794004 - weiß / white matt

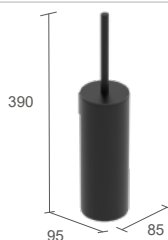

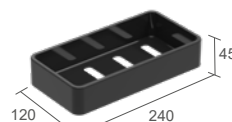

030672 - schwarz / black matt
030674 - weiß / white matt



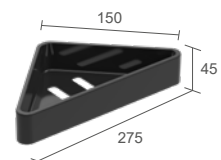



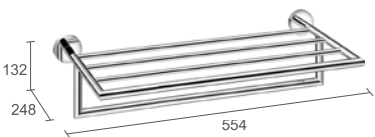
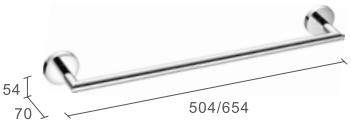
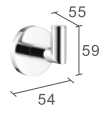
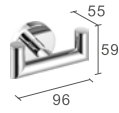
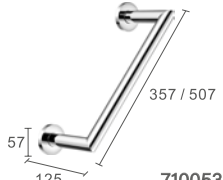
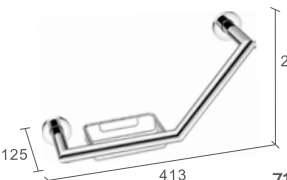
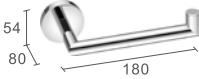
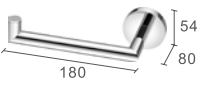
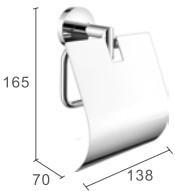
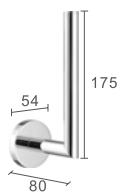

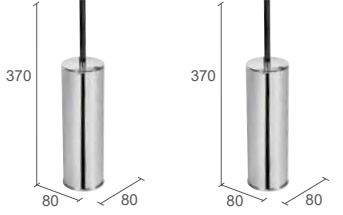

033677 - schwarz / black matt
034677 - weiß / white matt

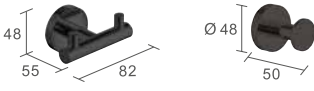

033671 - schwarz / black matt
034671 - weiß / white matt

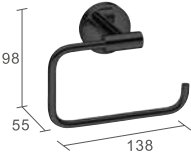
 <p>710059</p>	 <p>710003 710052</p>	 <p>710006</p>
 <p>710014</p>	 <p>710053 710054</p>	 <p>710056</p>
 <p>710008</p>	 <p>710061</p>	 <p>710013</p>
 <p>710009</p>	 <p>710010</p>	 <p>Free standing Freistehend 030633</p> <p>Wall mounted Wandmontage 030707</p>

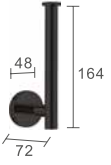
 <p>105 231 498</p> <p>740001</p>	 <p>48 64 498/648</p> <p>740002 740013</p>	 <p>108 153 250 ml 91</p> <p>030615</p>
 <p>98 107 74</p> <p>740010</p>	 <p>Ø 48 50</p> <p>740016</p>	 <p>48 55 82</p> <p>740004</p>
 <p>98 55 138</p> <p>740007</p>	 <p>98 55 138</p> <p>740066</p>	 <p>132 56 138</p> <p>740006</p>
 <p>48 164 72</p> <p>740017</p>	 <p>48 72 164</p> <p>740008</p>	 <p>48 72 164</p> <p>740065</p>
 <p>357 119 98</p> <p>740009</p>	 <p>84 360</p> <p>740018</p>	

 <p>48 64</p> <p>348/648</p> <p>740047 740054</p>	 <p>48</p> <p>55 82</p> <p>Ø48</p> <p>50</p> <p>740050 740045</p>	 <p>65</p> <p>129 118</p> <p>740053</p>
 <p>98</p> <p>107 74</p> <p>740052</p>	 <p>132</p> <p>56 138</p> <p>740038</p>	 <p>98</p> <p>55 138</p> <p>740042</p>
 <p>48</p> <p>72</p> <p>164</p> <p>740043</p>	 <p>48</p> <p>72</p> <p>164</p> <p>740046</p>	 <p>370</p> <p>80 80</p> <p>030708</p>
 <p>357</p> <p>119 98</p> <p>740044</p>		

C
O
M
P
L
E
M
M
E
N
T
A
R
Y





Mit edler Schraubenabdeckung / With fine screw covering

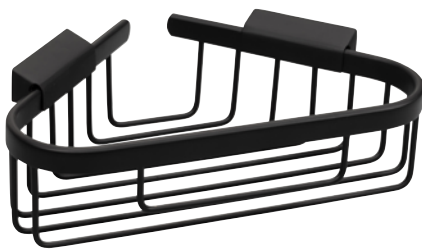

030706

Eckseifenkörbchen
Messing mit
Pulverbeschichtung /
Corner Soap basket
Brass with powder coating

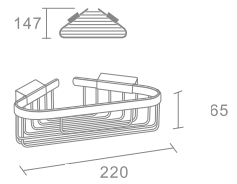

030461/ 030466

Eckseifenkörbchen
Messing, verchromt /
Corner Soap Basket
Brass, chrome finish

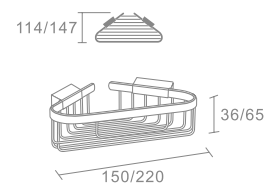



030509
Eckseifenkörbchen
Messing, verchromt /
Corner Soap Basket
Brass, chrome finish

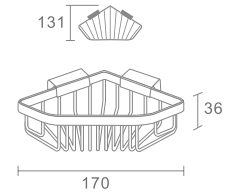

030462
Eckseifenkörbchen
Messing, verchromt /
Corner Soap Basket
Brass, chrome finish

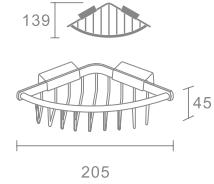

030533
Eck-Ablage
Messing, verchromt /
Corner Shelf
Brass, chrome finish

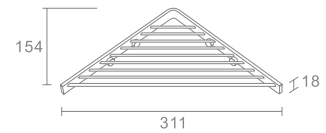

030464
Seifenkörbchen
Messing, verchromt /
Soap Basket
Brass, chrome finish

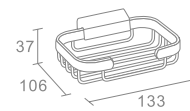

030463
Seifenkörbchen
Messing, verchromt /
Soap Basket
Brass, chrome finish

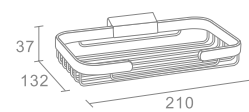



030618
Handtuchring /
Towel Ring

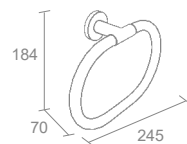



030614

Seifenspender CARLTON
Satinierteres Glas. Messing, verchromt /
Soap Dispenser CARLTON
Iced glass. Brass, chrome finish



030527

Haken
Messing, verchromt /
Hook
Brass, chrome finish



030416

Wäscheleine
Messing, verchromt /
Clothes Line
Brass, chrome finish

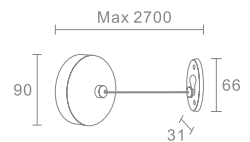

030494

Wäscheleine
Messing, verchromt /
Clothes Line
Brass, chrome finish

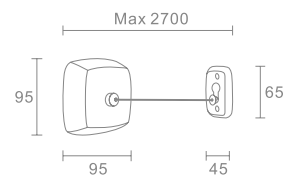



Hygienebaghalter /
Sanitary Bag Dispenser

030628

Kunststoff, verchromt /
Sanitary Bag Dispenser

030662

Kunststoff, schwarz matt /
Plastic, black matt

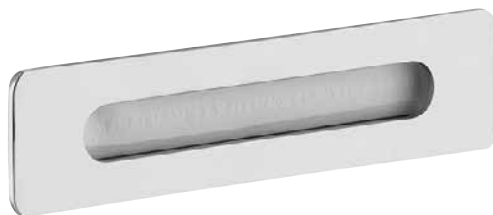
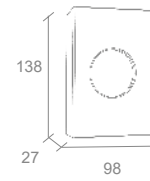

Kosmetiktuchspender zum Einbau
Einbaumaße: 264 x 130 x 76 mm /
Built-in Tissue Dispenser
Built-in dimensions: 264 x 130 x 76 mm

030449

Messing, verchromt /
Brass, chrome finish

030710

Messing, schwarz matt /
Brass, black matt

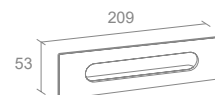
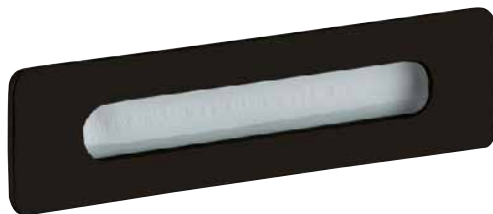



Kosmetiktuchspender CUBE /
Tissue Dispenser CUBE

030506

Kunststoff, verchromt /
Plastic, chrome finish

030661

Kunststoff, schwarz matt /
Plastic, black matt

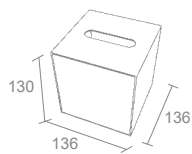

030724

Kosmetiktuchspender
ABS-Kunststoff, verchromt /
Tissue Dispenser
ABS-plastic, chrome finish

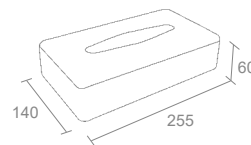





030485

Badezimmerhocker ZANZIBAR

Sitz: PVC, weiß, gepolstert / Gestell: Metall, verchromt /
Bathroom Stool ZANZIBAR

Seat: PVC, white, padded / Legs: Metal, chrome finish



030089

Badezimmerhocker PURI

Sitz: ABS-Kunststoff, weiß / Gestell: Metall, verchromt /
Bathroom Stool PURI

Seat: ABS-plastic, white / Legs: Metal, chrome finish



030483

Badezimmerhocker ANTIGUA

Sitz: PVC, weiß, gepolstert / Gestell: Metall, verchromt /
Bathroom Stool ANTIGUA

Seat: PVC, white, padded / Legs: Metal, chrome finish





PERSONENWAAGEN BATHROOM SCALES



030653

STEP

Elektronisch
6-mm-starkes Sicherheitsglas
Tragkraft max. 150 kg
Teilung 100 g
Umschaltbar auf Pfund (lbs)
Step-on-Funktion
4 Gewichtssensoren
Automatische Abschaltung
1 x 3V Lithium Batterie
Material Rahmen und Unterteil:
ABS Kunststoff /
Electronic
6 mm-thick safety glass
Capacity max. 150 kg
Graduation 100 g
Switchable to pounds (lbs)
Step-on technology
4 integrated sensors
Auto shut-off
1 x 3V lithium battery
Material frame and underpart: ABS plastic



PERSONENWAAGEN



030626

NEVIS

Elektronisch
 6-mm-starkes Sicherheitsglas
 Tragkraft max. 150 kg
 Teilung 100 g
 Umschaltbar auf Pfund (lbs)
 Step-on-Funktion
 4 Gewichtssensoren
 Automatische Abschaltung
 3 x 1,5V-AAA-Batterien
 Material Unterteil: ABS-Kunststoff /
 Electronic
 6 mm-thick safety glass
 Capacity max. 150 kg
 Graduation 100 g
 Switchable to pounds (lbs)
 Step-On technology
 4 integrated sensors
 Auto shut-off
 3 x 1.5V-AAA batteries

338 330 | 21/35



030475

FUTURA

Elektronisch
 6-mm-starkes Sicherheitsglas
 Tragkraft max. 200 kg
 Teilung 100 g
 Umschaltbar auf Pfund (lbs)
 4 Gewichtssensoren
 Automatische Abschaltung
 Long-life Lithium Batterie
 Material Unterteil: korrosionsgeschützte
 Epoxid- Kunststoffbeschichtung /
 Electronic
 6 mm-thick safety glass
 Capacity max. 200 kg
 Graduation 100 g
 Switchable to pounds (lbs)
 4 integrated sensors
 Auto shut-off
 Long-life Lithium battery
 Material underpart: Corrosion resistant
 Epoxy-plastic coating

300 300 | 35



030544

TEMPO

Elektronisch
 8-mm-starkes Sicherheitsglas
 Tragkraft max. 180 kg
 Teilung 100 g
 Umschaltbar auf Pfund (lbs)
 4 Gewichtssensoren
 Automatische Abschaltung
 80 x 40 mm Display-Anzeige mit
 blauer Hintergrundbeleuchtung
 4x AAA Batterien
 Material Unterteil: ABS Kunststoff /
 Electronic
 8 mm-thick safety glass
 Capacity max. 180 kg
 Graduation 100 g
 Switchable to pounds (lbs)
 4 integrated sensors
 Auto shut-off
 80 x 40 mm LCD display
 with blue backlight
 4x AAA batteries
 Material underpart: ABS plastic



030490

BOHEMIA

Mechanisch - Extra groß
 Großzügige Trittläche
 Verzerrungsfreie Glasscheibe
 Solide Konstruktion
 Tragkraft max. 160 kg
 Teilung 500 g
 Anzeige in Kilo und Pfund
 Material: Metall, korrosions-
 geschützte Emailbeschichtung /
 Mechanical - Extra Large
 Comfortable platform
 Fog-free glass lens
 Durable construction
 Capacity max. 160 kg
 Graduation 500 g
 Display kg and lbs
 Material: metal / corrosion
 resistant enamelled coating





HYGIENE EIMER WASTE BINS

ABSENKAUTOMATIK & STABILES PEDALSYSTEM

Ein patentiertes Hydrauliksystem ermöglicht das geräuscharme Absenken des Deckels. Das verstärkte Pedal verteilt die Kraft gleichmäßig. Ein solides System, das über 100.000 Betätigungen ermöglicht. /

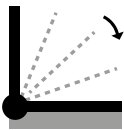

SILENT SOFT CLOSE SYSTEM

Intelligent soft-close function controlled by a patented hydraulic lid system. Rib-reinforced steel pedal distributes foot force equally. Extending service life in upwards of 100,000 steps.



ANTI-FINGERABDRUCK

Hochwertiger Edelstahl mit spezieller Anti-Fingerabdruck-Beschichtung. Die Oberfläche bleibt frei von Abdrücken und ist einfacher zu reinigen. /



FINGERPRINT RESISTANT

High-quality stainless steel with fingerprint resistant coating keeps the bin clean and easy to maintain.



BEUTELFIXIERUNG

Plastikbeutel lassen sich mittels einer Befestigungsöse am Inneneimer problemlos befestigen. /

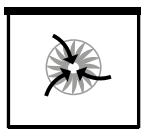

PLASTIC BAG FIXER

Plastic bag fixer helps secure the bag with no visible excess, keeping the bags neat and orderly.



SICHERER STAND

Kunststoffboden mit rutschfesten, oberflächenschonenden Pads geben dem Eimer Stabilität.



SOLID BASE

Plastic bottom, non-skid base and insulated pads are gentle on the floor and keeps the bin steady.



PRESTIGE



PRESTIGE

Hygieneeimer

Herausnehmbarer Kunststoffeinsatz
Edelstahl,

Step Bin

Removable plastic inner bin
Stainless steel

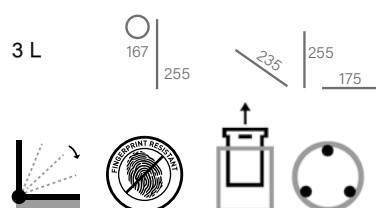

030654
chrom, gebürstet /
brushed chrome

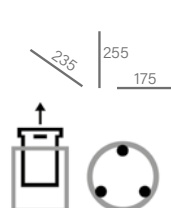

030692
schwarz /
black

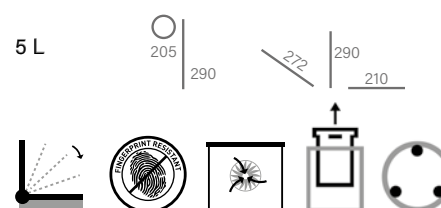

030655
chrom, gebürstet /
brushed chrome

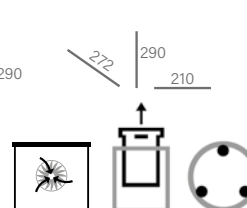

030691
schwarz /
black





Gelebte Nachhaltigkeit. Dank des schlichten Kunststoffdeckels hinterlassen herabfallende Gegenstände keine unschönen Dellen im Deckel. So bleibt er lange schön und ein übermäßiger Austausch kann vermieden werden. / Living sustainability. Thanks to the simple plastic lid, falling objects do not leave unsightly dents in the lid. This means it stays beautiful for a long time and excessive replacement can be avoided.

030657

PRESTIGE

Hygieneeimer - 5 L

Herausnehmbarer

Kunststoffeinsatz

Edelstahl, gebürstet /

Step Bin - 5 L

Removable plastic inner bin

Stainless steel, brushed finish

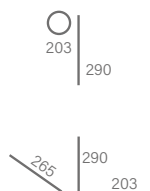

Herausnehmbarer, solider INNENEIMER

Verstärktes Gelenk mit Tragegriff /

Durable lift-out INNER BUCKET catches messy drips

Strong back handle





Ideal für Suiten, Apartments oder Ferienwohnungen.
EZ STAY Hygieneeimer für einen unbeschwerten Aufenthalt. /
Ideal for suite, apartment or extended stay applications.
The EZ STAY BIN makes your guest's stay easier.

LANGLEBIG
Extra breites Pedal verteilt die Kraft gleichmäßig. Ein solides Pedalsystem gewährleistet über 100.000 Betätigungen. /
DURABLE
Rib-reinforced extra large steel pedal distributes foot force equally, extending service life in upwards of 100,000 steps.



2-FACH INNENEIMER
Zwei separate Inneneimer für einfache Mülltrennung und Müllentsorgung. /
DOUBLE INNER BUCKETS
Double inner liners for easy separation and recycling.



STAY-OPEN-FUNKTION
Komfortable Deckelverankerung bei längerem Gebrauch. /
STAY OPEN DESIGN
Lid lock-out for convenient longer term usage.



030659

PRESTIGE EZ STAY

Hygieneeimer - 10 L + 9 L
Zwei herausnehmbare Kunststoffeinsätze
Edelstahl, gebürstet /
Step Bin - 10 L + 9 L
Two removable plastic inner bins
Stainless steel, brushed finish

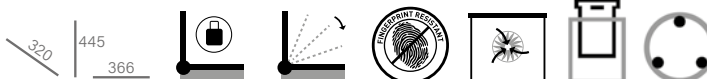



ABNEHMBARER RING INNENEIMER OHNE ABDECKUNG
 Offener Eimer für mühelose Abfallbeseitigung. Abnehmbarer Ring und Inneneimer mit Abfallbeutelfixierung und Henkel ermöglichen eine saubere Entsorgung. /
LIFT-OFF LID INNER BUCKET OPEN TOP
 Open mouth design for effortless trash discard. Lift-off lid and removable liner with waste bag fixer and sure-grip handle make for fast easy trash disposal.

030660

PRESTIGE

Abfallbehälter - 9 L

Herausnehmbarer

Kunststoffeinsatz

Edelstahl, gebürstet /

Waste Bin - 9 L

Removable plastic inner bin

Stainless steel, brushed finish





Abfalltrennung im Hotel ist eine echte Herausforderung. Für das Gästezimmer haben unsere Abfallbehälter PRESTIGE mit herausnehmbaren Einsätzen eine saubere und einfache Lösung parat. Je nach Anforderung, mit 2 oder 3 Fächern erhältlich. Und falls Sie eine geschlossene Version bevorzugen, ist unser rechteckiger Treteimer mit 2 Fächern die richtige Wahl. ./

Waste separation in hotels is a real challenge. Our PRESTIGE waste bins with removable inner bins provide a clean and simple solution for guest rooms. Available with 2 or 3 compartments, to suit your requirements. And if you prefer a closed version, our rectangular pedal bin with 2 compartments is the right choice.

030720

PRESTIGE

Abfallbehälter - 3 x 3,5 L
 3 herausnehmbare Kunststoffeinsätze
 (schwarz, grün, blau)
 Edelstahl, gebürstet /
 Waste Bin - 3 x 3,5 L
 3 removable plastic inner bins
 (black, green, blue)
 Stainless steel, brushed finish

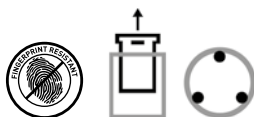

030712

PRESTIGE

Abfallbehälter - 2 x 5 L
 2 herausnehmbare Kunststoffeinsätze
 (schwarz, grün)
 Edelstahl, gebürstet /
 Waste Bin - 2 x 5 L
 2 removable plastic inner bins
 (black, green)
 Stainless steel, brushed finish





Unser selbstlöschender Abfallbehälter ist nicht brennbar und kommt in super schlichem schwarz. Die Konstruktion des Deckels sorgt dafür, dass im Falle eines Brandes im Abfallbehälter, der Rauch die Frischluftzufuhr versperrt und das Feuer erstickt. Material und Farbe sind mit der höchsten Klasse -nicht brennbar- zertifiziert, so sind Sie auf der sicheren Seite in Sachen Brandschutz und Style. / Our self-extinguishing waste bin is non-flammable and comes in super sleek black. The design of the lid ensures that in the event of a fire in the waste bin, the smoke blocks the supply of fresh air and smothers the fire. The material and color are certified with the highest class - non-combustible- so you are on the safe side in terms of fire protection and style.

030627

Abfallbehälter- 13 L
 Feuerfest. Abnehmbarer Deckel
 Kunststoffbodenring
 Metall, schwarz /
 Waste Bin - 13 L
 Fire-proof. Removable top
 Plastic ring at the bottom
 Metal, black





GÄSTEZIMMER
GUESTROOM



Alle Aliseo Wasserkocher verfügen über den patentierten STRIX Schutzmechanismus. Dieser gewährleistet die automatische Abschaltung bei Erreichen des Kochvorgangs, bei Entnahme des Behälters von der Basisstation und den Trockenlaufschutz. Eine maximale Sicherheit für die Gäste. / All Aliseo kettles incorporate patented STRIX thermostatic controls ensuring maximum guest safety: auto shut-off, boil dry protection and steam shut-down functions.



1.



2.



3.



1. Einfaches Reinigen durch besonders breiten Ausguss und nahtlos gezogenen Edelstahlbehälter
Doppelwändiges Gehäuse: innen - Edelstahl, außen - wärmeisolierender Kunststoff
2. Verriegelter Sicherheitsklapdeckel, öffnet auf Knopfdruck mit schmaler Ausgusstülle - zum einfachen, tropfenfreien Ausgießen
3. Ergonomisch geformter Kunststoff-Griff (bleibt angenehm kühl) mit beleuchtetem Ein-/Ausschalter /

1. Extra wide mouth and seamless canister improves ease of cleaning
Double wall construction – stainless steel cylinder with a cool-touch stain resistant thermoplastic exterior
2. Sturdy interlocking safety lid with wide-mouth aperture - easy to fill and clean
3. Full grip safety handle with illuminated power switch

BONJOUR

0,6 Liter Füllmenge
Integriertes Heizelement
Kabellos, 360° drehbar
Abschaltautomatik
Trockenlaufsicherung
Kontrollleuchte
Deckel mit Sicherheitsverriegelung
Doppelwandiges Gehäuse:
innen - Edelstahl
außen - wärmeisolierender Kunststoff

0.6 litre capacity
Integrated heating element
Cordless, 360° rotation
Automatic shut-off
Boil dry protection
Indicator light
Lid with safety interlock
Double wall construction
Inner stainless steel cylinder
Insulated thermoplastic exterior

170281

schwarz matt /
black matt

170282

elfenbein/ schwarz /
ivory/black



220-240 V, 50/60 Hz 1000 W



185 - mit Sockel / with base
165 - ohne Sockel / without base

Ø 134 - Sockel / base
190 max. Breite / width



PUZZLE

Ablagebehälter
Material: Melamin
mit Porzellan-Optik
schwarz /
Sachet Box
Material: Melamine
with porcelain optic
black

170240
151 x 55 x 76 mm

170241
76 x 55 x 76 mm



Einziehbares Netzkabel /
Retractable power cord

TEA X-PRESS

0,8 Liter Füllmenge
Integriertes Heizelement
Kabellos, 360° drehbar
Doppelwandiges Gehäuse:
- innen: Edelstahl
- außen: wärmeisolierender Kunststoff
Deckel mit Sicherheitsverriegelung
Abschaltautomatik
Trockenlaufsicherung
Kontrollleuchte
Strix-Controller
Füllstandsanzeige mit LED-Licht

0.8 litre capacity
Concealed heating element
Cordless, 360° rotation
Double layer kettle:
- inside: stainless steel
- outside: insulated cool touch housing
Lid with secure safety interlock
Automatic shut-off
Boil dry protection
Indicator light
Strix controller
Water gauge with LED light

CE CB

220-240 V, 50/60 Hz 1000-1200 W



170300

schwarz matt /
black matt



210 - mit Sockel / with base
190 - ohne Sockel / without base

Ø 137 - Sockel /base
185 - max. Breite / width





Elegante verchromte Oberfläche /
Elegant chrome finish

EMPIRE

0,8 Liter Füllmenge	0.8 litre capacity
Integriertes Heizelement	Concealed heating element
Kabellos, 360° drehbar	Cordless, 360° rotation
Abschaltautomatik	Automatic shut-off
Trockenlaufsicherung	Boil dry protection
Kontrollleuchte	Indicator light
Deckel mit Verriegelung	Lid with safety interlock
Edelstahlgehäuse	Stainless steel housing



220-240 V, 50/60 Hz 1000-1200 W



170167

chrom/schwarz /
chrome/black



170 - mit Sockel / with base
150 - ohne Sockel / without base

Ø 158 - Sockel / base
210 max. Breite / width

SMALLER IS SMARTER – WATER & ENERGY SAVING

MINI

0,5 Liter Füllmenge	0.5 litre capacity
Integriertes Heizelement	Integrated heating element
Kabellos, 360° drehbar	Cordless, 360° rotation
Abschaltautomatik	Automatic shut-off
Trockenlaufsicherung	Boil dry protection
Kontrollleuchte	Indicator light
Deckel mit Sicherheitsverriegelung	Lid with safety interlock
Edelstahlgehäuse	Stainless steel housing



220-240 V, 50/60 Hz 1000 W



170211

chrom gebürstet/schwarz /
brushed chrome/black

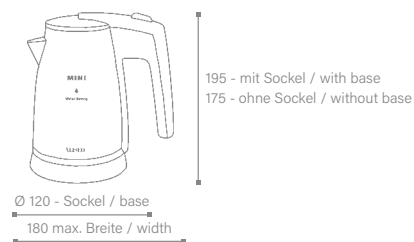

1. Ergonomisch geformter Kunststoff-Griff (bleibt angenehm kühl) mit beleuchtetem Ein-/Ausschalter
 2. Geringe Standfläche durch 0,5 L Design
Edelstahlgehäuse, Oberfläche chrom gebürstet
 3. 360° Basisstation mit Strix-Controller für die Sicherheit der Gäste
 4. Verriegelter Sicherheitsklappdeckel, öffnet auf Knopfdruck
 5. Schmale Ausgusstülle - zum einfachen, tropfenfreien Ausgießen /
1. Safety-grip handle with illuminated power switch
 2. Cylindrical low-profile 0.5 liter footprint;
stainless steel construction with brushed surface finish
 3. 360° STRIX interface platform ensures guest's safety while optimizing performance
 4. Sturdy interlocking safety lid
 5. Easy pour spout with wide mouth fill



MINI



SPACE OASIS kombiniert Wasser- und Energiesparfunktionen auf kleinster Fläche. /
SPACE OASIS efficiency combines water and energy saving functions in a small space



3
IN ONE



KERAMIKTASSE / CERAMIC MUG
schwarz-weiß /
black/white



HOLZTABLETT / BRIDGE TRAY
Hochwertiges, robustes Bambusholz
Schubfach aus langlebigem Melamin /
Elegantly finished bamboo construction
Durable melamine condiment tray



MINI
Wassersparendes 0,5 L Design /
0,5 liter water- saving design

SPACE OASIS

Wasserkocher-Tablett-Set /
Water Kettle Tray Set **170259**

Holztablett /
Bridge Tray **170254**

Tasse /
Mug **170258**

MINI Wasserkocher
chrom gebürstet / schwarz
Weitere Information siehe Seite 9

BRIDGE TRAY, Holztablett mit Schubfach
260 x 44 x 160 mm (B x H x T)
Material: Bambus und Melamin
mahagoni/matt schwarz

Zwei Keramik-Tassen
250 ml
schwarz, innen weiß
Höhe 100 mm, Ø 85 mm

MINI Water Kettle
brushed chrome / black
Further information on page 3

BRIDGE TRAY, wooden tray with drawer
260 x 44 x 160 mm (W x H x D)
Material: bamboo and melamine
mahogany / matt black

Two Ceramic Mugs
250 ml
black, inside white
Height 100 mm, Ø 85 mm

COURTESY TRAY



* Abgebildet mit / Shown with Wasserkocher/ kettle BONJOUR Art. 170282 und Behälter Puzzle /
Puzzle boxes Art. 170241
Kaffeemaschine, Tassen und Kapseln sind Dekoration / Coffee machine, cups and capsules are
decoration.

Schmale Tablett in Porzellan-Optik bieten einen attraktiven Rahmen für Kaffeekapsel-
maschinen und / oder Tee-Service-Präsentationen.

Langlebige Melamin-Konstruktion ist leicht zu reinigen und widerstandsfähig gegen
Rissbildung. Einzeln oder zusammen in Kombination mit Kaffeemaschinen und
Wasserkocher Ensembles. /

Low profile porcelain optic tablets provide an attractive setting for coffee capsule machi-
nes and/or Tea service presentations. Durable melamine construction is easy to clean
and resistant to splintering and cracking. Works individually or collectively in combina-
tion with any number of similar coffee machines and tea kettle ensembles.

170277

COURTESY TRAY

schwarz

200 x 16 x 400 mm

Material: Melamin, Porzellan-Optik

black

200 x 16 x 400 mm

Material: Melamine with porcelain optic

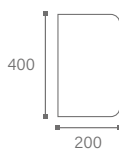



* Abgebildet mit / Shown with Wasserkocher/ kettle EMPIRE Art. 170167

- 01. Servierblech 324 x 21 x 131 mm /
Serving tray 324 x 21 x 131 mm
- 02. Grundblech 400 x 20 x 330 mm /
Base tray 400 x 20 x 330 mm
- 03. Produktablage 130 x 40 x 100 mm /
Sachet tray 130 x 40 x 100 mm

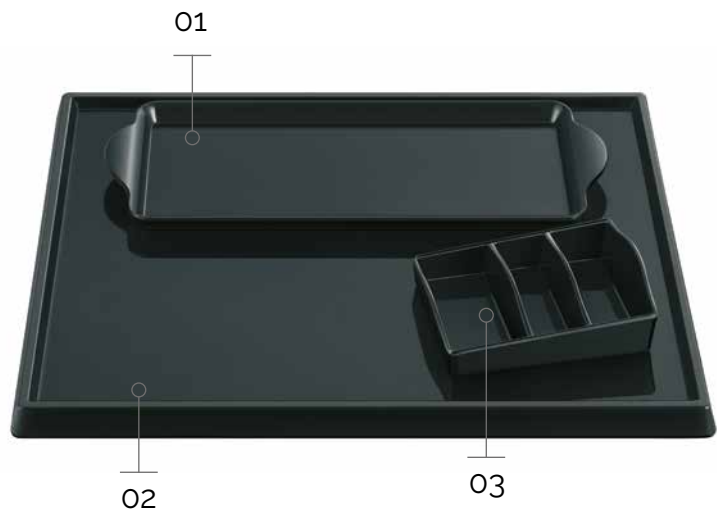

WELCOME TRAY SOLUTION

Tabletset	Tray Set
Material: Melamin mit Porzellan-Optik schwarz	Material: Melamine with porcelain optic black

Komplettes Set / Complete Set	170229
Grundblech / Base Tray	170226
Servierblech / Serving Tray	170227
Produktablage / Sachet Tray	170228

L O N D O N E R
LEDER ACCESSOIRES
LEATHER ACCESSORIES

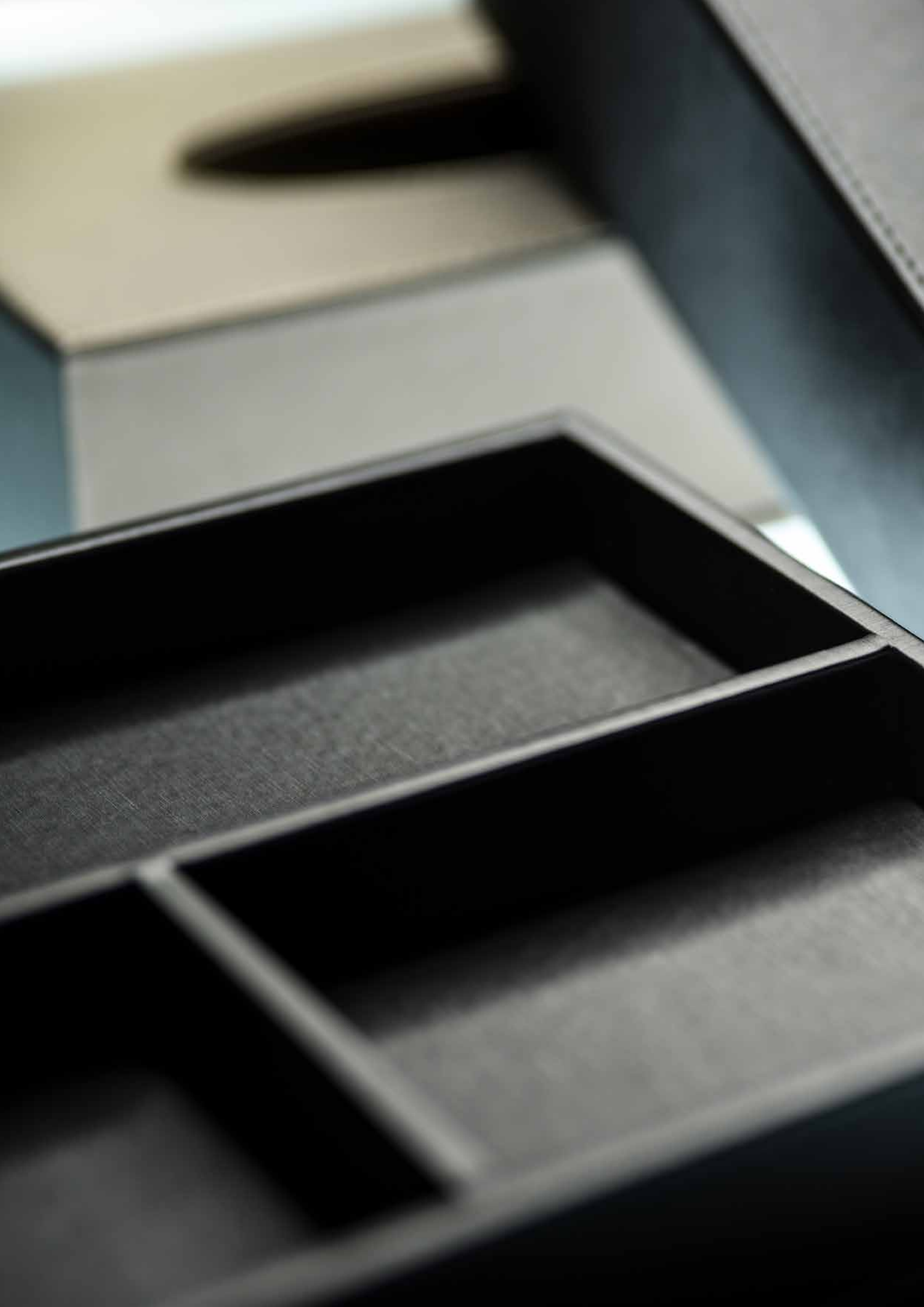



Die LONDONER Kollektion macht den Service perfekt. Sie ist die optimale Ergänzung in Gästezimmer und Restaurant, an der Rezeption sowie in allen weiteren Servicebereichen.

Das qualitative Kunstleder verspricht neben Langlebigkeit auch optisch ein luxuriöses Statement. Abgerundet durch eine perfekte Naht am Randabschluss. Handgemacht natürlich.

Die Standardfarben schwarz und taupe fügen sich unaufdringlich in nahezu alle Interiors ein und verleihen dem Gesamtkonzept eine besonders klassische Note.

Sollte unter den unzähligen Artikeln in der LONDONER Kollektion einmal nicht das passende Maß oder die perfekte Ausführung dabei sein, kontaktieren Sie uns gerne. Abhängig von Menge und Lieferzeit sind auch Sonderanfertigungen möglich. /

The LONDONER collection will add the finishing touch to your service. It is the ultimate complement in guest rooms and restaurants, at reception and in all other service areas.

The high-quality artificial leather promises not only durability but also a luxurious visual statement. Rounded off with a perfect seam at the edge. Handmade, of course.

The standard colors black and taupe blend unobtrusively into almost all interiors and lend the overall concept a particularly classic touch.

If you cannot find the right size or the perfect fit among the countless items in the LONDONER collection, please do not hesitate to contact us. Custom-made products are also possible, depending on quantity and delivery time.

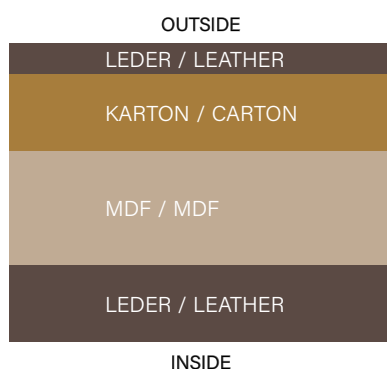

Der Aufbau: Alle LONDONER Lederaccessoires werden in einer Sandwich-Konstruktion gefertigt. Die Stabilität im Inneren liefert eine dünne MDF-Platte. Auf der Aussenseite erhält diese durch eine weiche Kartonage ihre unverwechselbar federnde Griffigkeit. Aussen und innen bildet feinstes Kunstleder (PU) optisch und haptisch den perfekten Abschluss. Alle Komponenten werden mittels eines ungiftigen, geruchlosen Klebers aufeinander kaschiert. /

The construction: All LONDONER leather accessories are manufactured in a sandwich construction. A thin MDF board provides the stability on the inside. On the outside, soft cardboard gives it its unmistakably springy feel. The finest artificial leather (PU) on the outside and inside provides the perfect visual and haptic finish. All components are joined using a non-toxic, odorless adhesive.

FLECKENENTFERNUNG

Alle Artikel aus der LONDONER Kollektion sind von sehr guter Qualität und bedürfen nur eines geringen Pflegeaufwandes. Jedoch, regelmäßige Reinigung erhält die Schönheit der feinen Stücke. Ebenso kann es einmal sein, dass ein Fleck oder eine Verunreinigung aufgetreten ist. In diesem Fall warten Sie nicht länger, sondern entfernen diese umgehend. Ein leicht feuchtes (Microfaser-)Tuch reicht meistens aus. Bitte achten Sie dabei auf eine möglichst geringe Menge Wasser im Tuch. Sollte es nötig sein ein Reinigungsmittel einzusetzen, verzichten Sie unbedingt auf aggressive Reiniger oder Chemikalien auf Säurebasis. Eine milde Seife ist völlig ausreichend. Nach der Reinigung nehmen Sie überschüssige Seifenreste mit einem feuchten Tuch ab. Um zurückbleibende Schlieren und Flecken zu vermeiden, mit einem sauberen Tuch trockenreiben.

STAIN REMOVAL

All items from the LONDONER collection are of very good quality and require very little care. However, regular cleaning preserves the beauty of these fine pieces. It is also possible that a stain or soiling may occur. In this case, do not wait any longer, but remove it immediately. A slightly damp (microfiber) cloth is usually sufficient. Please ensure that the amount of water in the cloth is as small as possible. If it is necessary to use a cleaning agent, do not use aggressive cleaning agents or acid-based chemicals. A mild soap is completely sufficient. After cleaning, remove excess soap residue with a damp cloth. To avoid leaving streaks and stains, wipe dry with a clean cloth.



Dank handgearbeiteter Ziernähte eine Klasse für sich... und trotzdem langlebig, wasserabweisend und stabil /

A class of its own thanks to handcrafted decorative stitching... and yet durable, water-repellent and stable..



L O N D O N E R
C O L O R L I N E





Wer eine aristokratische Atmosphäre schätzt, wird unsere beiden Standardfarben schwarz und taupe lieben. Denn sie sind in ihrer Dezenz nicht zu übertreffen.

Wessen Herz beim Gedanken an eine schöne Farbe jedoch höher schlägt, liegt mit der LONDONER COLOR LINE genau richtig. Nicht weniger edel, aber um einen Farbtupfer reicher.

Die Farbauswahl umfasst bereits 60 fein abgestimmte Töne. Da ist bestimmt der passende dabei. Sollten Sie dennoch einen individuellen Farbton wünschen, bieten wir Ihnen auch diesen gerne an. Denn das Leben ist bunt... /

Anyone who appreciates an aristocratic atmosphere will love our two standard colors black and taupe. Because they can't be beaten in their subtlety.

But if your heart beats faster at the thought of a beautiful color, the LONDONER COLOR LINE is just right for you. No less elegant, but with a splash of color.

The color selection already includes 60 finely balanced shades. You are sure to find the right one. However, if you would like an individual shade, we will be happy to offer you this too. Because life is colorful..



Verfügbarkeit/Lieferzeit

Alle Artikel der LONDONER Kollektion sind in der Regel in den klassischen Farben schwarz und taupe bei uns vorrätig und sofort versandbereit.

Die 60 Standardfarben der LONDONER COLOR LINE produzieren wir gerne für Sie auf Auftrag. Bitte beachten Sie in diesem Fall die Mindestbestellmenge von 50 Stück je Farbe, die Sie notfalls auf verschiedene Artikel verteilen können. /

Availability/Delivery time

All items in the LONDONER collection are generally available from stock in the classic colors black and taupe and are ready for immediate dispatch.

We are happy to produce the 60 standard colors of the LONDONER COLOR LINE for you to order. In this case, please note the minimum order quantity of 50 pieces per color, which you might distribute among different items.



Farbe 28 /
color 28

Farbe 54 /
color 54

Farbe 50 /
color 50

Farbe 51 /
color 51

Farbe 69 /
color 69

Farbe 32 /
color 32

Farbe 13 /
color 13



Farbe 22 /
color 22

Farbe 42 /
color 42

Farbe 67 /
color 67



COLOR LINE SELECTOR

Mit dem **COLOR LINE** SELECTOR erhalten Sie die Möglichkeit alle Farben ins richtige Licht zu rücken. Soweit verfügbar, senden wir Ihnen diesen auf Anfrage gerne zu. ✓

The **COLOR LINE** SELECTOR gives you the opportunity to show all colors in the right light. If available, we will be happy to send it to you on request.

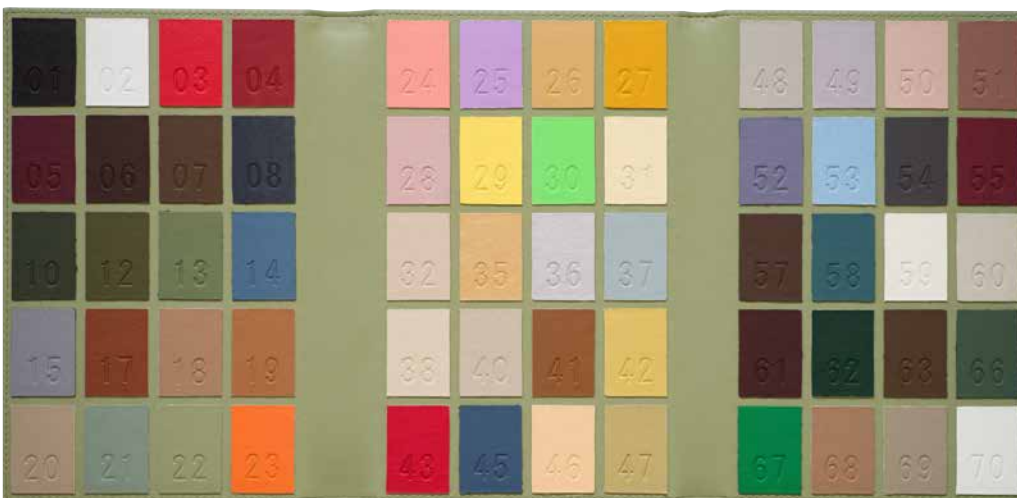



Verfügbarkeit/Lieferzeit

Alle Artikel der LONDONER Kollektion sind in der Regel in den klassischen Farben schwarz und taupe bei uns vorrätig und sofort versandbereit.

Availability/Delivery time

All items in the LONDONER collection are generally available from stock in the classic colors black and taupe and are ready for immediate dispatch.



190058 - taupe
 190083 - schwarz / black
 Tablett groß
 mit Schubfach /
 Tray big
 with drawer



190057 - taupe
 190084 - schwarz / black
 Tablett klein
 mit Schubfach /
 Tray small
 with drawer





190001 - taupe
190068 - schwarz / black
 Tablett /
 Tray



190003 - taupe
190070 - schwarz / black

Ablagebehälter
 mit zwei Fächern /
 Sachet Box
 with two compartments



190002 - taupe
190069 - schwarz / black

Ablagebehälter
 mit zwei Fächern /
 Sachet Box
 with two compartments



190063 - taupe
190089 - schwarz / black
 Tablett - Meeting /
 Tray - Meeting





* Abgebildet mit / Shown with Wasserkocher/ kettle BONJOUR Art. 170282.
Tasse / Mug Art. 170258
Kaffeemaschine & Kapseln sind Dekoration. / Coffee machine & capsules are decoration.



IN
2 GRÖSSEN
IN
2 SIZES

190061 - taupe

190087 - schwarz / black

Tablett

mit 2 Löchern ø 55 mm für Kabel des Wasserkochers /
Tray

with 2 holes ø 55 mm for cable of water kettle



190060 - taupe

190086 - schwarz / black

Tablett

mit Loch ø 55 mm für Kabel des Wasserkochers /
Tray

with hole ø 55 mm for cable of water kettle





190062 - taupe

190088 - schwarz / black

Utensilienbox

mit 5 Fächern und arretierbarem Deckel /
Stationary Box
with 5 compartments and hinged lid



190009 - taupe

190072 - schwarz / black

Utensilienbox

mit 3 Fächern /
Stationary Box
with 3 compartments



190065 - taupe

190091 - schwarz / black

Kapselbehälter

mit wendbarer Einlage für 2 oder 4 Kapseln /
Coffee Capsule Box
with reversible insert for 2 or 4 capsules



190059 - taupe

190085 - schwarz / black

Minibar-Tablett /
Minibar Tray





190004 - taupe

190071 - schwarz / black

Glas-/Tassenuntersetzer /
Coaster



190006 - taupe

190051 - schwarz / black

Eiswürfelbehälter, 1 Liter
mit Deckel und Zange. Edelstahl /
Ice Cube Container, 1 litre
with lid and tongs. Stainless steel





190016 - taupe

190052 - schwarz / black

Kosmetiktuchspender
mit magnetischer Bodenklappe /
Tissue Dispenser
with magnetic trap at the bottom



190017 - taupe

190078 - schwarz / black

Kosmetiktuchspender
mit magnetischer Bodenklappe /
Tissue Dispenser
with magnetic trap at the bottom





190011 - taupe

190073 - schwarz / black

Notizblockunterlage
mit Vertiefungen für Block und Stift /
Note Pad
with cut-outs for note pad and pen



190012 - taupe

190074 - schwarz / black

Notizblockhalter
mit magnetischer Klemmschiene
und Stifthalter /
Note Pad Holder
with magnetic fold and pen holder





190028 - taupe

190081 - schwarz / black

Info-Mappe A4
mit 2-Ring-Mechanik /
Service Binder A4
with two ring clamp



190027 - taupe

190054 - schwarz / black

Info-Mappe A5
mit 2-Ring-Mechanik /
Service Binder A5
with two ring clamp



190066 - taupe

190092 - schwarz / black

Info-Mappe A4
mit Stifthalter und 4 Fächern/
Service Binder A4
with pen holder and 4 compartments





190030 - taupe

190053 - schwarz / black

Tischauflage
mit magnetischer Klemmschiene /
Desk pad
with magnetic fold



190064 - taupe

190090 - schwarz / black

Tischauflage /
Desk pad



190029 - taupe

190082 - schwarz / black

Rechnungsmappe
mit magnetischer Klemmschiene
und Stifthalter /
Bill Presenter
with magnetic fold and pen holder





190014 - taupe

190076 - schwarz / black

TV-Mappe mit Fach für Fernbedienung
und Sichtfenster für Programmliste /
Remote Control Binder
with compartment for TV channel list



190015 - taupe

190077 - schwarz / black

Fernbedienungsständer /
Remote Control Holder



190018 - taupe

190079 - schwarz / black

Info-Wandhalter
z.B. für Wäscheservice /
Service Wall Holder
e.g. for laundry information

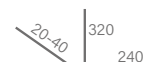



190013 - taupe

190075 - schwarz / black

Tischuhr - batteriebetrieben
mit Weckfunktion und Beleuchtung /
Table Clock - Battery-Powered
with alarm and lighting



190019 - taupe

190048 - schwarz / black

Kleiderbürste
Holz mit Aufhängeschlaufe /
Clothes Brush
wood with hanger

380

190020 - taupe

190049 - schwarz / black

Schuhlöffel
Holz mit Aufhängeschlaufe /
Shoe Horn
wood with hanger

380



190023 - taupe

190080 - schwarz / black

Zeitschriftenständer
mit zwei Fächern /
Magazine Holder
with two compartments



LONDONER



190067 - taupe
190093 - schwarz / black
THE LONDONER
 Abfallbehälter - 2 x 6 L
 Mit zwei herausnehmbaren Metalleinsätzen
 103 x 334 x 205 mm/
 Waste Bin - 2 x 6 L
 With two removable metal liners
 103 x 334 x 205 mm



190026 - taupe
190094 - schwarz / black
THE LONDONER
 Abfallbehälter - 10 L
 Herausnehmbarer Metalleinsatz /
 Waste Bin - 10 L
 Removable metal liner



520694
 Optionaler separater Einsatz
 passend für Art. 190026 & 190094 /
 Optional Waste Bin Separator
 fits Art. 190094 & 190026





190025 - taupe

190055 - schwarz / black

THE LONDONER

Abfallbehälter - 9 L

Metall mit abnehmbarer Kunstleder-Ummantelung/

Waste Bin - 9 L

Metal with removable casing

○
225 | 270





190001

Tablett
Tray

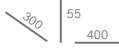

190002

Ablagebehälter
Sachet Box



190003

Ablagebehälter
Sachet Box



190065

Kaffeekapselbehälter
Coffee Capsule Box



190060

Tablett
Tray

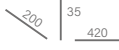

190061

Tablett
Tray



190057

Tablett
Tray



190058

Tablett
Tray



190059

Minibar-Tablett
Minibar Tray



190009

Utensilienbox
Storage Tray



190062

Utensilienbox
Storage Tray

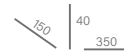

190004

Untersetzer
Coaster



190063

Tablett-Meeting
Tray-Meeting



190064

Tischauflage
Desk Pad



190006

Eiswürfelbehälter
Ice Cube Container



190016

Kosmetiktuchspender
Tissue Dispenser



190017

Kosmetiktuchspender
Tissue Dispenser



190013

Tischuhr
Table Clock



190014

TV-Mappe
Remote Control Binder



190015

Fernbedienungsständer
Remote Control Holder





190030
Tischauflage
Desk Pad
405 | 14
500



190027
Info-Mappe A5
Service Binder A5
40 | 245
193



190028
Info-Mappe A4
Service Binder A4
40 | 320
246



190066
Info-Mappe A4
Service Binder A4
30 | 320
246



190029
Rechnungsmappe
Bill Presenter
20 | 240
128



190011
Notizblockunterlage
Note Pad
155 | 7
165



190012
Notizblockhalter
Note Pad Holder
170 | 7
130



190018
Info-Wandhalterung
Service Wall Holder
20-40 | 320
240



190019
Kleiderbürste
Clothes Brush
380



190023
Zeitschriftenständer
Magazine Holder
330 | 230
330



190025
Abfallbehälter, 9 L
Waste Bin, 9 L
225 | 270



190026
Abfallbehälter, 10 L
Waste Bin, 10 L
235 | 363
235



190067
Abfallbehälter, 2 x 6 L
Waste Bin, 2 x 6 L
300 | 250
300



520694
Metalleinsatz, türkis,
für Art. 190094
Waste Bin Separator
Metal, turquoise
fits Art. 190094
205 | 334
103



190068

Tablett
Tray



190069

Ablagebehälter
Sachet Box



190070

Ablagebehälter
Sachet Box



190091

Kaffee kapsel
behälter
Coffee Capsule Box



190086

Tablett
Tray



190087

Tablett
Tray



190084

Tablett
Tray



190083

Tablett
Tray



190085

Minibar-Tablett
Minibar Tray

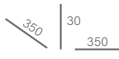

190072

Utensilienbox
Storage Tray

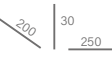

190088

Utensilienbox
Storage Tray

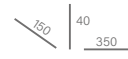

190071

Untersetzer
Coaster



190089

Tablett-Meeting
Tray-Meeting

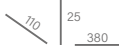

190090

Tischauflage
Desk Pad

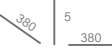

190051

Eiswürfelbehälter
Ice Cube Container



190052

Kosmetiktuch-
spender
Tissue Dispenser

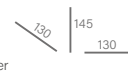

190078

Kosmetiktuch-
spender
Tissue Dispenser

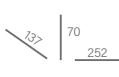

190075

Tischuhr
Table Clock



190076

TV-Mappe
Remote Control
Binder

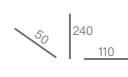

190077

Fernbedienungs-
ständer
Remote Control Holder

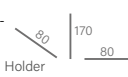



190053
Tischauflage
Desk Pad
405 | 14
500



190054
Info-Mappe A5
Service Binder A5
40 | 245
193



190081
Info-Mappe A4
Service Binder A4
40 | 320
246



190092
Info-Mappe A4
Service Binder A4
30 | 320
246



190082
Rechnungsmappe
Bill Presenter
20 | 240
128



190073
Notizblockunterlage
Note Pad
155 | 7
165



190074
Notizblockhalter
Note Pad Holder
170 | 7
130



190079
Info-Wandhalterung
Service Wall Holder
20-40 | 320
240



190048
Kleiderbürste
Clothes Brush
380

190049
Schuhlöffel
Shoe Horn
380



190080
Zeitschriftenständer
Magazine Holder
330 | 230
330



190055
Abfallbehälter, 9 L
Waste Bin, 9 L
225 | 270



190094
Abfallbehälter, 10 L
Waste Bin, 10 L
235 | 363
235



190093
Abfallbehälter, 2 x 6 L
Waste Bin, 2 x 6 L
300 | 250
300



520694
Metalleinsatz, türkis,
für Art. 190094
Waste Bin Separator
Metal, turquoise
fits Art. 190094
205 | 334
103

KOFFERABLAGEN
LUGGAGE RACKS



KOFFERABLAGEN

KOFFERABLAGE

Mit Rückenlehne
Beige Gurtbänder
Material: Edelstahl
Oberfläche, verchromt

geklappt (B x H x T)
67,5 x 89 x 9 cm

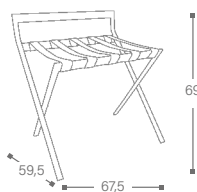

080069

chrom /
chrome

LUGGAGE RACK

With back
Beige straps
Material: stainless steel
Surface, chrome plated

folded (W x H x D)
67,5 x 89 x 9 cm



KOFFERABLAGE

Schwarze Gurtbänder
Material: Stahlrohr

Mit Rückenlehne
geklappt (B x H x T)
68 x 85 x 10 cm

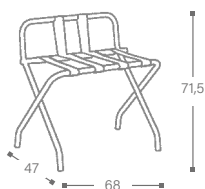

080053

chrom /
chrome

080088

schwarz /
black

LUGGAGE RACK

With black straps
Material: steel tube

With back
folded (W x H x D)
68 x 85 x 10 cm



Ohne Rückenlehne
geklappt (B x H x T)
68 x 65 x 9 cm

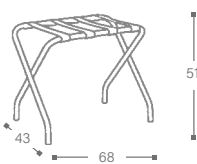

080055

chrom /
chrome

080087

schwarz /
black

Without back
folded (W x H x D)
68 x 65 x 9 cm



KOFFERABLAGE

Schwarze Gurtbänder
Material: Holz, Buche

Mit Rückenlehne
geklappt (B x H x T)
60 x 77 x 10 cm

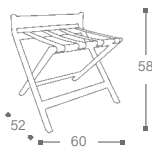

Ohne Rückenlehne
geklappt (B x H x T)
60 x 65 x 7 cm

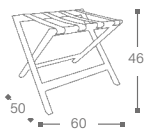

LUGGAGE RACK

With black straps
Material: wood, beech

With back
folded (W x H x D)
60 x 77 x 10 cm

080047 Buche, natur /
natural beech

080049 gebeizt, Mahagoni /
mahogany, stained

080086 gebeizt, schwarz /
black, stained

080043 Buche, natur /
natural beech

080045 gebeizt, Mahagoni /
mahogany stained

080089 schwarz /
black



Mahagoni, gebeizt / mahogany, stained

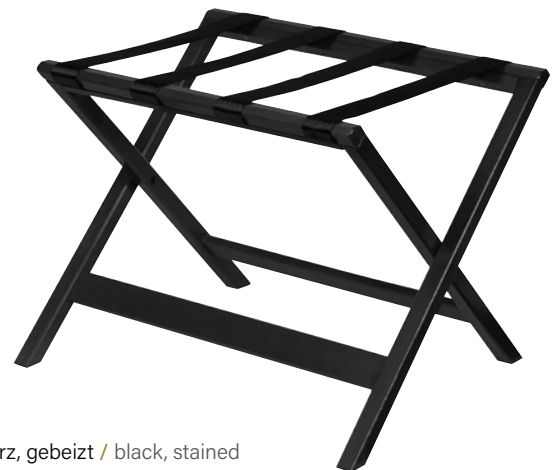

schwarz, gebeizt / black, stained



Buche, natur / natural beech

BÜGELSTATIONEN
IRONING SOLUTIONS





ENGINEERED FOR PERFORMANCE

- Automatische Abschaltung für mehr Sicherheit - horizontal nach 30 Sekunden / vertikal nach 8 Minuten
- Textilfreundliche Anti-Haft-Keramiksohle
- Maximale Wärmeregulung auf 200° C schützt Textilien bei Fehlbedienung
- Einfache Befüllung des Wassertanks mit Wasserstandsanzeige, Kapazität 200 ml/6.8 oz. /
- Automatic Hotel safety shut-off horizontal after 30 seconds/vertical after 8 minutes
- E-Z-glide non-stick CERAMIC soleplate
- Dial Fabric Control locks out at 200° C - guards against accidental scorching of fabric
- Easy front fill clear water tank: capacity 200 ml/6.8 oz.



- 01. Fingertip-Dampffunktion / Finger-tip Steam Function
- 02. Dampffunktion wahlweise mit komprimiertem Dampf- oder Wasserspray / Full-range spray adjustment with temperature control light
- 03. Mehrstufige Temperaturregelung für verschiedenste Textilien und Materialien / Rotating Fabric Control Dial for different textiles
- 04. Ergonomischer Antirutsch-Griff ermöglicht sicheres und bequemes Bügeln / Ergonomic anti-slip handle for safe and comfortable ironing

160162
STEAMWORKS

Hotel-Dampfbügeleisen
weiß/silber
Energiesparend - 1650-2000 W
2-fach automatische
Sicherheitsabschaltung
- horizontal nach 30 Sekunden /
- vertikal nach 8 Minuten
Anti-Haft-Keramiksohle
Anti-Kalk- und Anti-Tropf-System
Selbstreinigungssystem
Kabellänge 2,4 m
Gewicht 1,1 kg

Hotel steam iron
white/silver
Energy saving - 1650-2000 W
Double safety automatic shut-off
-horizontal after 30 seconds/vertical after 8 minutes
Non-stick ceramic soleplate
Anti-calc and anti-drip system
Self cleaning system
Cord length 2.4 m
Weight 1.1 kg

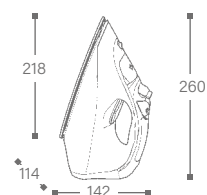

CE CB 220-240 V, 50/60 Hz 1650-2000 W



SAHARA - Works When Dry ...





- 01. Anti-Haft-Beschichtung /
E-Z glide non-stick coating
- 02. 2-fach automatische Abschaltung /
Double safety automatic shut-off
- 03. Ergonomischer Antirutsch-Griff ermöglicht
bequemes Bügeln /
Ergonomic anti-slip handle for comfortable
ironing



160172
SAHARA

Hotel-Trockenbügelleisen
silber/champagner
EcoSmart - 900-1100 W
2-fach automatische Sicherheitsabschaltung
- horizontal nach 30 Sekunden /
- vertikal nach 8 Minuten
Temperaturregler
Anti-Haft-Keramiksohle
Kabellänge 2,4 m
Gewicht 0,8 kg

Hotel dry iron
silver/champagne
EcoSmart - 900-1100 W
Double safety automatic shut-off
- horizontal after 30 seconds/
- vertical after 8 minutes
Fabric control dial
Non-stick ceramic soleplate
Cord length 2.4 m
Weight 0.8 kg

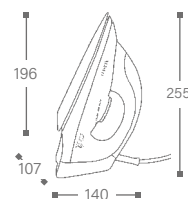

CE 220-240 V, 50/60 Hz 900-1100 W

ON-BOARD FIXED HOLDER

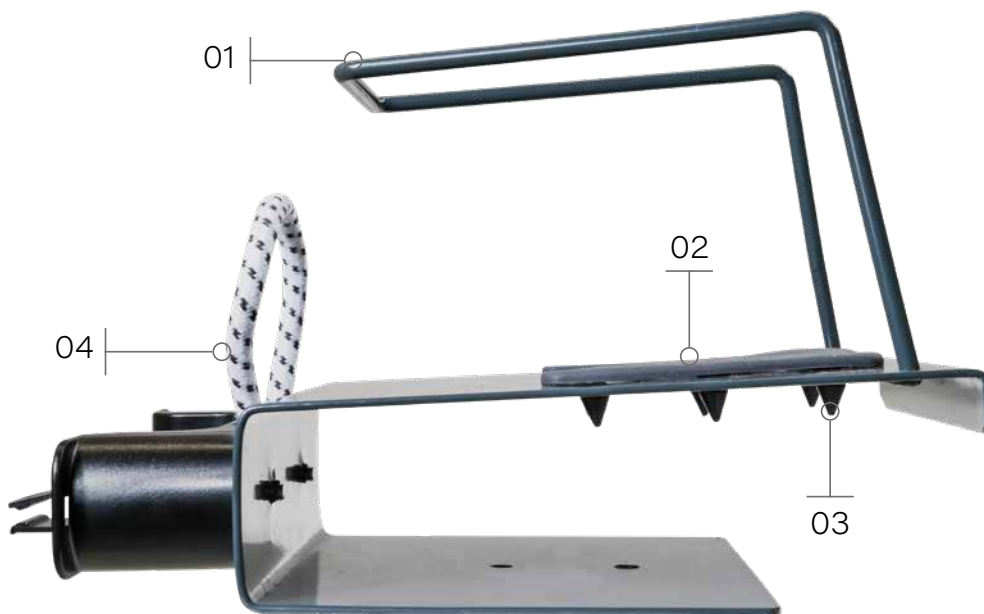

- 01. Passend für Trockenbügelleisen SAHARA und Dampfbügelleisen STEAMWORKS /
Accommodates both SAHARA dry Iron and STEAMWORKS steam iron
- 02. Bügelleisen liegt geschützt in der Halterung auf rutschfesten, hitzebeständigen Silikonstreifen /
Iron rests securely in place on heat resistant non-slip silicone bumpers
- 03. Austauschbare Silikonstreifen sind fixiert durch überstehende Noppen /
Replaceable bumpers are fastened to the holder via soft-pointed silicone inserts
- 04. Diebstahlsicher - Bügelleisenkabel wird durch die Halterung fest mit Bügelbrett verbunden /
Theft protection – cable secured through the holder/board



Integrierter Kabelhalter mit Kabelklemme
für eine saubere einfache Aufbewahrung /
Integrated cable reel and clip for neat
easy storage

160192

SICHERHEITSHALTER FÜR BÜGELLEISEN
SAFETY CRADLE FOR IRON

passend zu Trockenbügelleisen Sahara und
Dampfbügelleisen Steamworks
Diebstahlsicher
grau/ schwarz
230 x 140 x 150 mm (B x H x T)

Suitable for dry iron Sahara und steam iron Steamworks
Theft protection
grey/ black
230 x 140 x 150 mm (W x H x D)



Diebstahlsichere Halterung zur Montage an Bügelbrett
 MI-PRO, MINI-MAX und Tischbügelbrett MINI-MEEE/
 Theft proof thru-bolted holder directly onto Aliseo boards:
 MI-PRO, MINI-MAX, MINI-MEEE



Bügeleisen ist zur Schrankaufbewahrung in
 hängender Position an seinem Platz gesichert /
 Irons are secured safely in place for board
 storage in hanging position





Doppelrohrkonstruktion
 - maximale Beanspruchbarkeit /
 Twin-tube construction
 - maximum strength

Stabiler rutschfester Gummifuß /
 Stable non-skid rubber footing

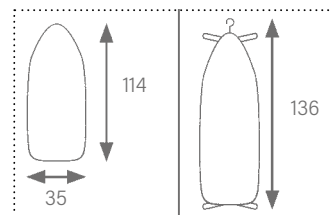

Gewicht / Weight

Bügelbrett / Board Mi-Pro	4,6 kg
Halterung / Holder	1,0 kg
Bügeleisen / Iron Sahara	0,8 kg
Bügeleisen / Iron SteamWorks	1,1 kg
Gesamt / Total	6,4 / 6,7 kg

Bügeleisen ist in hängender Position
 an seinem Platz gesichert /
 Irons are secured safely in place for
 board storage in hanging position

Bequemes Bügeln in der richtigen Höhe
 Höhenverstellbar 67-73-79-85 cm /
 Comfortable ironing at the right height
 Height adjustment 67-73-79-85 cm



MI-PRO

Bügelbrett mit Sicherheitshalterung
 Diebstahlsicher - Kabelrolle ist
 durch die Halterung gesichert
 Feuerfester, gepolsterter Bezug
 Höhenverstellbar 67-73-79-85 cm
 Elektroanschluss mit Netzkabel (1,8 m)
 Klappbarer Aufhängehaken
 Material Gestell: Stahlrohr
 Pulverbeschichtung, dunkelgrau

Ironing board with fixed safety iron holder
 Theft protection -
 cable reel secured through the holder
 Anti-Fire cover with foam underlay
 Height adjustable 67-73-79-85 cm
 Integrated Schuko extension cord (1,8 m)
 Fold-away suspension hook
 Material legs: tubular steel
 Powder coated dark grey finish

160200

MI-PRO SAHARA

Bügelbrett mit Sicherheitshalterung
 und Trockenbügeleisen /
 Ironing board with safety holder
 and dry iron

160203

MI-PRO STEAMWORKS

Bügelbrett mit Sicherheitshalterung
 und Dampfbügeleisen /
 Ironing board with safety holder
 and steam iron

160212

MI-PRO

Bügelbrett ohne Sicherheitshalterung /
 Ironing board without safety holder



Minimum Profile. Maximum Board Space.

Speziell entwickelt für die Aufbewahrung in kleinen Schränken /
Specifically engineered for small cabinet storage

160219

MINI-MAX SAHARA

Bügelbrett mit Sicherheitshalterung
und Trockenbügelleisen /
Ironing board with safety holder
and dry iron

160222

MINI-MAX STEAMWORKS

Bügelbrett mit Sicherheitshalterung
und Dampfbügelleisen /
Ironing board with safety holder
and steam iron

160225

MINI-MAX

Bügelbrett ohne Sicherheitshalterung /
Ironing board without safety holder

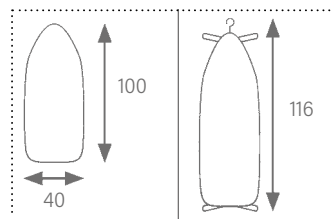

Gewicht / Weight

Bügelbrett / Board Mini-Max	4,7 kg
Halterung / Holder	1,0 kg
Bügelleisen / Iron Sahara	0,8 kg
Bügelleisen / Iron SteamWorks	1,1 kg
Gesamt / Total	6,5 / 6,8 kg

Für Sahara &
SteamWorks
Hotel-Bügeleisen
For Sahara &
SteamWorks
Hotel Irons



Bequemes Bügeln in der richtigen Höhe
Höhenverstellbar 60-63-66-69-72-75-78 cm /
Comfortable ironing at the right height
Height adjustment 60-63-66-69-72-75-78 cm

Stabiler rutschfester Gummifuß /
Stable non-skid rubber footing



MINI-MAX

Bügelbrett mit Sicherheitshalterung
Diebstahlsicher - Kabelrolle ist durch die Halterung gesichert
Feuerfester, gepolsterter Bezug
Höhenverstellbar 60-63-66-69-72-75-78 cm
Elektroanschluss mit Netzkabel (1,8 m)
Klappbarer Aufhängehaken
Stabiles Gestell mit Transportsicherung
Material Gestell: Stahlrohr
Pulverbeschichtung, dunkelgrau /
Ironing board with fixed safety iron holder
Theft protection - cable reel secured through the holder
Anti-Fire cover with foam underlay
Height adjustable 60-63-66-69-72-75-78 cm
Integrated Schuko extension cord (1,8 m)
Fold-away suspension hook
Sturdy frame with transport safety lock
Material legs: tubular steel
Powder coated dark grey finish



MINI-MEEE

TISCHBÜGELBRETT

Mit Sicherheitshalterung
 Diebstahlsicher - Kabelrolle ist durch die Halterung gesichert
 Feuerfester, gepolsterter Bezug
 Klappbarer Aufhängehaken
 Material Gestell: Stahlrohr
 Pulverbeschichtung, schwarz

TABLE TOP IRONING BOARD

With fixed safety iron holder
 Theft protection -
 cable reel secured through the holder
 Anti-Fire cover with foam underlay
 Fold-away suspension hook
 Material legs: tubular steel
 Powder coated black finish

160194

MINI-MEEE SAHARA

Tischbügeltbrett mit Sicherheitshalterung /
 und Trockenbügelleisen

Table top ironing board with safety holder
 and dry iron

160197

MINI-MEEE STEAMWORKS

Tischbügeltbrett mit Sicherheitshalterung /
 und Dampfbügelleisen

Table top ironing board with safety holder
 and steam iron

160188

MINI-MEEE

Tischbügeltbrett ohne Sicherheitshalterung /
 Table top ironing board without safety holder

Gewicht / Weight

Bügeltbrett / Board E-Zee	1,9 kg
Halterung / Holder	1,0 kg
Bügelleisen / Iron Sahara	0,8 kg
Bügelleisen / Iron SteamWorks	1,1 kg
Gesamt / Total	3,7 / 4,0 kg

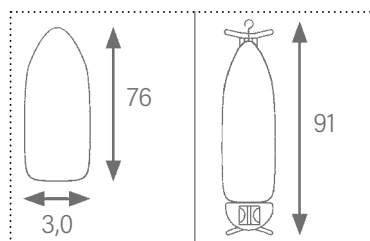

Für Sahara &
SteamWorks
Hotel-Bügeleisen
For Sahara &
SteamWorks
Hotel Irons



Stabiles Gestell mit
Transportsicherung
Sturdy frame with
platform safety lock



ALISEO HANG-UP



Bügeleisenaufhängung
 Hitzebeständige Rückwand
 Montage mit oder ohne Haken für
 Bügelbrett /
 Hang-up organizer
 Heat resistant back plate
 Mounted with or without
 board hanger

160130
 für Trockenbügelleisen Sahara
 schwarz /
 for dry iron Sahara
 black

160183
 für Dampfbügelleisen SteamWorks
 schwarz /
 for steam iron SteamWorks
 black

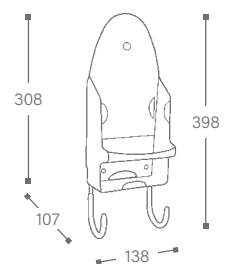

Hitzebeständige Eisenablage /
Heat Resistant Iron Rest



Bequemes Bügeln in der richtigen Höhe
Höhenverstellbar 70 - 77 - 84 - 89 cm /
Comfortable ironing at the right height
Height adjustment 70 - 77 - 84 - 89 cm

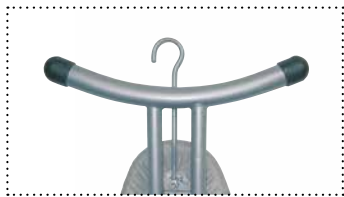

Klappbarer Aufhängehaken /
Fold-away suspension hook

Stabiler rutschfester Gummifuß /
Stable non-skid rubber footing



Elektroanschluss mit Netzkabel,
1,8 m Kabellänge /
Integrated Schuko extension cord,
1.8 m length

E-ZEE CONCEPT

Bügelbrett mit hitzebeständiger Bügeleisenablage
Feuerfester, gepolsterter Bezug
Höhenverstellbar 70-77-84-89 cm
Doppelrohrkonstruktion mit Transportsicherung
Material Gestell: Stahlrohr
Pulverbeschichtung, silber /
Ironing board with heat resistant iron rest
Anti-Fire cover with foam underlay
Height adjustment 70-77-84-89 cm
Durable double leg construction
with transport safety lock
Material legs: tubular steel
Powder coated silver finish

Gewicht / Weight

Bügelbrett / Board E-Zee	4,7 kg
Bügeleisen / Iron Sahara	0,8 kg
Bügeleisen / Iron SteamWorks	1,1 kg

160175
E-ZEE SAHARA
Bügelbrett mit Trockenbügeleisen /
Ironing board with dry iron

160167
E-ZEE STEAMWORKS
Bügelbrett mit Dampfbügeleisen /
Ironing board with steam iron

160111
E-ZEE
Bügelbrett /
Ironing board

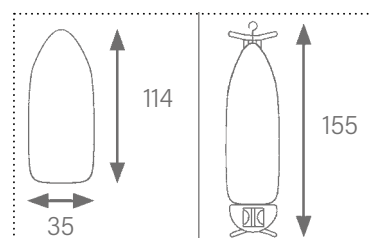

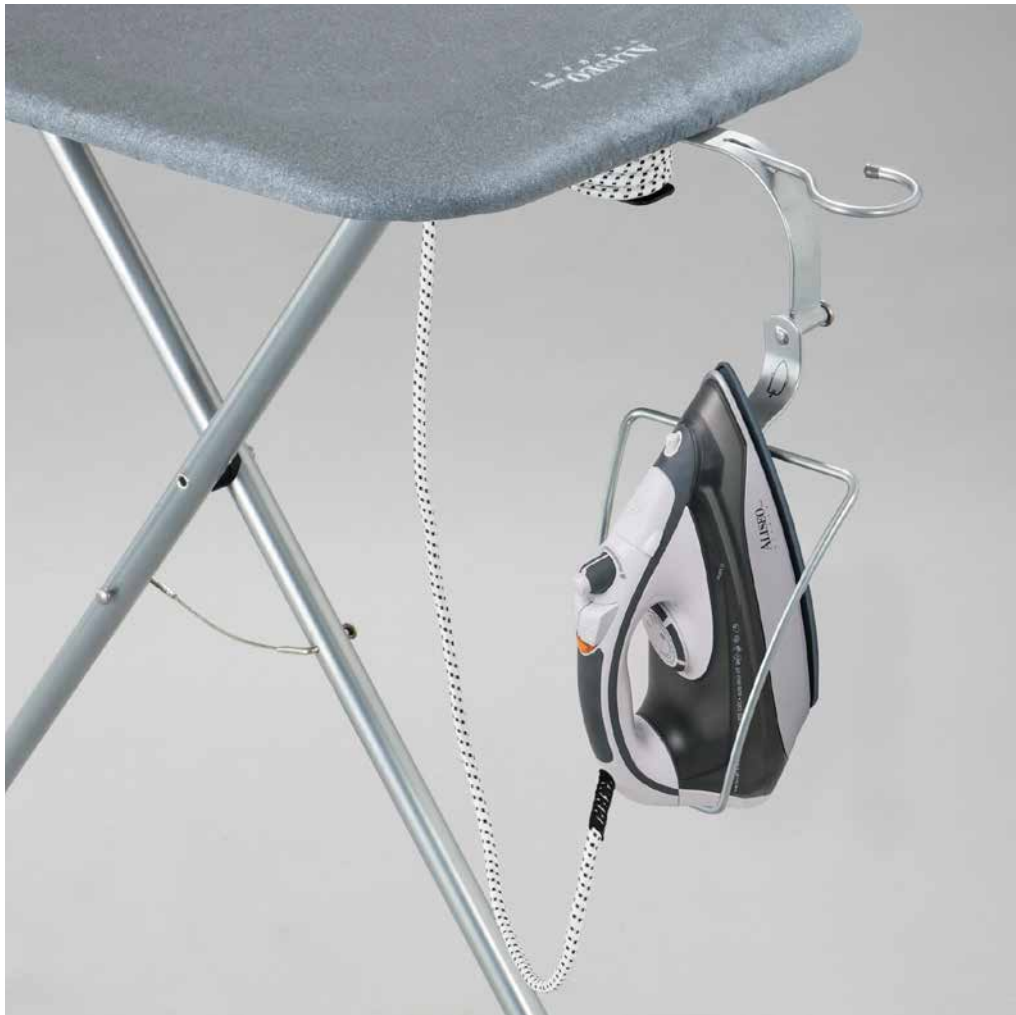

Elektroanschluss mit Netzkabel, 1,8 m Kabellänge /
Integrated Schuko extension cord, 1,8 m length

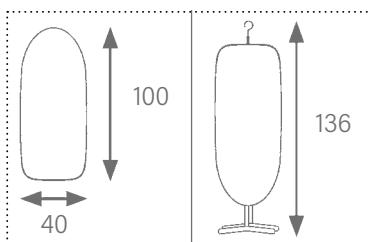

160178
SURF CENTER SAHARA
Bügelbrett mit Trockenbügelleisen /
Ironing board with dry iron

160164
SURF CENTER STEAMWORKS
Bügelbrett mit Dampfbügelleisen /
Ironing board with steam iron

160132
SURF BOARD
Bügelbrett ohne Bügelleisenhalterung /
Ironing board without iron safety cradle

SURF CENTER

Bügelbrett mit klappbarer Sicherheitshalterung
Feuerfester, gepolsterter Bezug
Höhenverstellbar 84-87-90 cm
Aufhängehaken
Stabiles Gestell mit Transportsicherung
Material Gestell: Stahlrohr
Pulverbeschichtung, silber /
Ironing board with fold-away safety cradle
Anti-Fire cover with foam underlay
Height adjustment 84-87-90 cm
Suspension hook
Sturdy frame with transport safety lock
Material legs: tubular steel
Powder coated silver finish

Gewicht / Weight

Bügelbrett / Board Surf	4,9 kg
Halterung / Holder	0,4 kg
Bügelleisen / Iron Sahara	0,8 kg
Bügelleisen / Iron SteamWorks	1,1 kg
Gesamt / Total	6,1 / 6,4 kg



Bequemes Bügeln in der richtigen Höhe
 Höhenverstellbar 84 - 87 - 90 cm /
 Comfortable ironing at the right height
 Height adjustment 84 - 87 - 90 cm













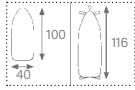

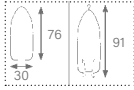

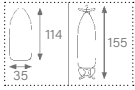

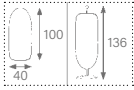
Für Sahara &
 SteamWorks
 Hotel-Bügeleisen
 For Sahara &
 SteamWorks
 Hotel Irons



Diebstahlsicher – Kabel ist fest mit dem
 Bügelbrett verbunden /
 Anti-theft protection - cable
 guard secured through the board

Stabiler rutschfester Gummifuß /
 Stable non-skid rubber footing

MODELLÜBERSICHT / PRODUCT OVERVIEW

MI-PRO	MINI-MAX	MINI-MEEE	E-ZEE	SURF
  160212 Bügelbrett Mi-Pro / Ironing Board Mi-Pro	  160225 Bügelbrett Mini-Max / Ironing Board Mini-Max	  160188 Tisch-Bügelbrett Mini-Meee / Table Top Ironing Board Mini-Meee	  160111 Bügelbrett E-Zee / Ironing Board E-Zee	  160132 Bügelbrett Surf / Ironing Board Surf
 160200 Bügelbrett Mi-Pro & Sicherheitshalterung & Trockenbügelleisen Sahara / Ironing Board Mi-Pro & Fixed Safety Holder & Dry Iron Sahara	 160219 Bügelbrett Mini-Max & Sicherheitshalterung & Trockenbügelleisen Sahara / Ironing Board Mini-Max & Fixed Safety Holder & Dry Iron Sahara	 160194 Tisch-Bügelbrett Mini-Meee & Sicherheitshalterung & Trockenbügelleisen Sahara / Table Top Ironing Board Mini-Meee & Fixed Safety Holder & Dry Iron Sahara	 160175 Bügelbrett E-Zee & Trockenbügelleisen Sahara / Ironing Board E-Zee & Dry Iron Sahara	 160178 Bügelbrett Surf & Sicherheitshalterung & Trockenbügelleisen Sahara / Ironing Board Surf & Safety Cradle & Dry Iron Sahara
 160203 Bügelbrett Mi-Pro & Sicherheitshalterung & Dampfbügelleisen SteamWorks / Ironing Board Mi-Pro & Fixed Safety Holder & Steam Iron SteamWorks	 160222 Bügelbrett Mini-Max & Sicherheitshalterung & Dampfbügelleisen SteamWorks / Ironing Board Mini-Max & Fixed Safety Holder & Steam Iron SteamWorks	 160197 Tisch-Bügelbrett Mini-Meee & Sicherheitshalterung & Dampfbügelleisen SteamWorks / Table Top Ironing Board Mini-Meee & Fixed Safety Holder & Steam Iron SteamWorks	 160167 Bügelbrett E-Zee & Dampfbügelleisen SteamWorks / Ironing Board E-Zee & Steam Iron SteamWorks	 160164 Bügelbrett Surf & Sicherheitshalterung & Dampfbügelleisen SteamWorks / Ironing Board Surf & Safety Cradle & Steam Iron SteamWorks



SAHARA

160172

Trockenbügelleisen Sahara /
Dry Iron Sahara



STEAMWORKS

160162

Dampfbügelleisen SteamWorks /
Steam Iron SteamWorks



HANG-UP

160130

für Trockenbügelleisen Sahara /
for Dry Iron Sahara

160183

für Dampfbügelleisen SteamWorks /
for Steam Iron SteamWorks



SICHERHEITSHALTER SAFETY CRADLE

160192

für Trockenbügelleisen Sahara und
Trockenbügelleisen Steamworks/
for Dry Iron Sahara and
for Steam Iron SteamWorks



UNSER ÖKOLOGISCHES
ENGAGEMENT



OUR GREEN COMMITMENT



OUR GREEN COMMITMENT

Als umweltbewusstes Unternehmen verfolgt Aliseo nachhaltige und umweltfreundliche Geschäftspraktiken und hält die Qualitätsmanagementstandards gemäß ISO 9001:2015 ein.

Durch die ständige Prozessoptimierung zur Erweiterung der Produktlebenszyklen und die Bereitstellung einer zunehmenden Zahl an EcoSmart-Produkten strebt Aliseo weiterhin danach, das Bewusstsein von Hoteliers und ihren Gästen hinsichtlich des ökologischen globalen Engagements zu stärken.

Bereits heute an die Zukunft denken und Verantwortung übernehmen! Da Nachhaltigkeit und verantwortungsvolles Denken auch in unserem Unternehmen eine große Rolle spielen, verpflichten wir uns aus Eigeninitiative mit der Unterzeichnung der WIN-Charta zum nachhaltigen Wirtschaften.

Die WIN-Charta ist das einzige Nachhaltigkeitsmanagementsystem für kleine und mittlere Unternehmen in Deutschland. Darüber hinaus erfüllen alle Aliseo-Produkte die europäische Richtlinie zur Beschränkung der Verwendung bestimmter gefährlicher Stoffe. Wo immer möglich und wann immer es möglich ist, werden wiederverwertbare Materialien verwendet.

As an Environmentally Conscious Company, Aliseo is dedicated to ensuring sustainable and environmentally positive business practices and conforms to the quality management standards as defined by ISO 9001:2015.

By consistently developing processes that expand product life cycles and by providing an increasing number of EcoSmart products, Aliseo remains committed to increasing the consciousness of the hotelier and their guests to the importance of an ecological global commitment.

Taking responsibility for our future TODAY! Since sustainability and responsible thinking plays an important role in our company, we commit ourselves to sustainable business practices in accordance with WIN-Charta guidelines. WIN-Charta is the only sustainability management system for small and medium-sized enterprises in Germany. In addition all Aliseo products comply with the European Directive on the Restriction of Hazardous Substances. Where appropriate and whenever possible recyclable materials are used.



ALISEO

G E R M A N Y

Leutkirchstraße 63, 77723 Gengenbach, Germany
Tel. +49 (0) 78 03-60 279-0
Fax +49 (0) 78 03-60 279-30
Internet: www.aliseo.de
E-Mail: info@aliseo.de